

**PAJUNK®**

***TrokaBone / TrokaCut***

*Aspiration and puncture cannulas  
for bone marrow biopsy*



**Bone marrow biopsy**

## TrokaCut and TrokaBone

# Cannula systems for bone marrow biopsy

The manufacture of cannula systems for biopsy has been the core competence of PAJUNK® for more than 45 years. Together with doctors from different fields, PAJUNK® develops sophisticated solutions for bone marrow biopsy, fine-needle biopsy, cutting and punch biopsy, brachytherapy and tumour markers. PAJUNK® offers three systems in the field of bone marrow biopsy: TrokaCut, TrokaBone and TrokaBone Sternal. They differ with respect to material usage, design and the field of application.



Tip with bevelled hollow grind

## TrokaCut

*the combined aspiration and punch  
cannula for pelvic crust puncture*



The semi-transparent plastic bayonet lock of **TrokaCut** allows the outer cannula and full stylet to be permanently connected to each other.

## TrokaBone

*the combined aspiration and punch  
cannula for pelvic crest puncture*



A stable metal anchoring system is used to fasten the outer cannula in the handle for **TrokaBone**. This complete system is manufactured from robust materials and is characterised by its excellent stability and the ergonomic handle.



Tip with bevelled hollow grind



Tip with trocar grind

## TrokaBone Sternal

*the puncture set for safe aspiration  
of bone marrow from the pelvic and  
sternum region*

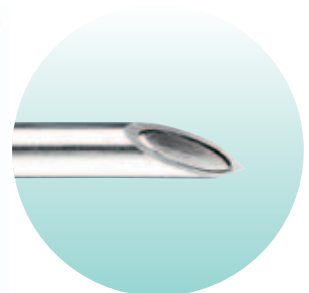

Tip with bevelled grind

## TrokaCut

# The complete system for bone marrow puncture

The TrokaCut puncture set of equipment from PAJUNK® is a cost effective complete system for the extraction of bone marrow samples. It is very easy to use during puncture and aspiration.

### Single biopsy

The TrokaCut set includes a stable full stylet with a sharp tip and bevelled hollow grind as well as an outer cannula with ejection stylet that are both provided with a graduation. The introductory aid covers the sharp tip of the outer cannula when extracting biopsy material and so prevents injuries.

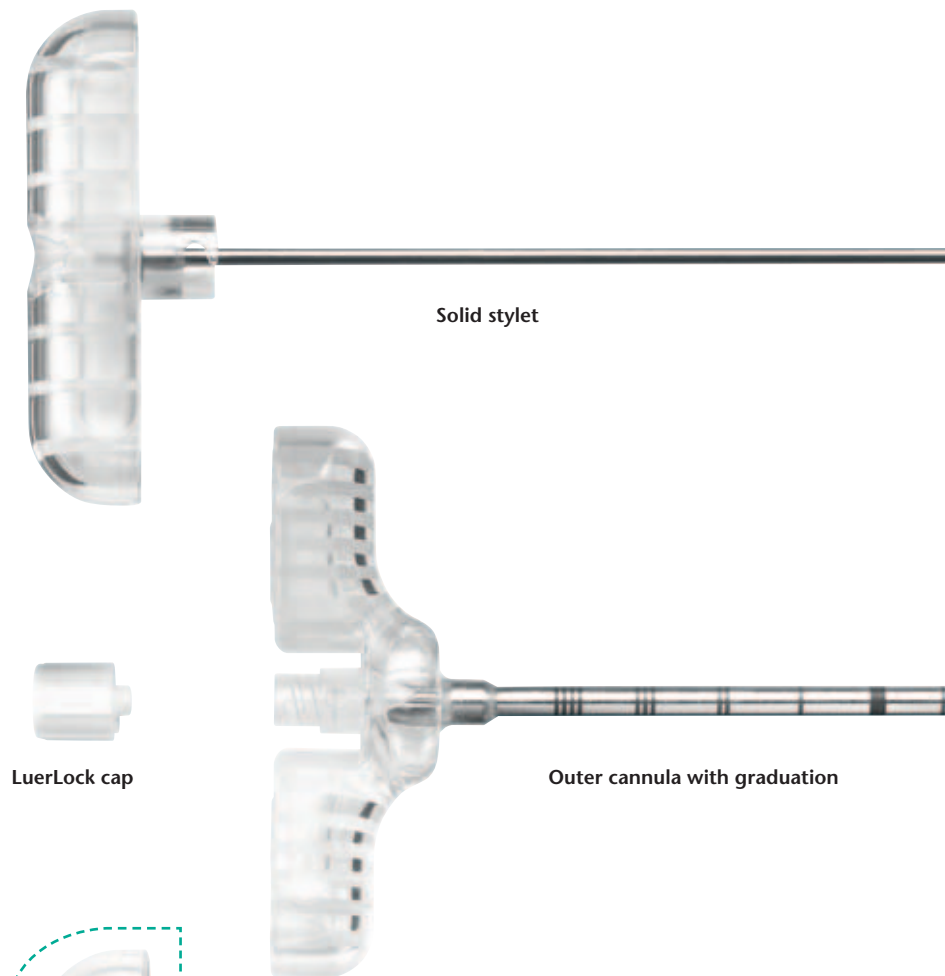

### Biopsy safety

It is recommended to use an inner cannula with a biopsy material chamber for a safe biopsy. This inner cannula collects the sample when penetrating and can be pulled out for extraction without having to change the position of the outer cannula.

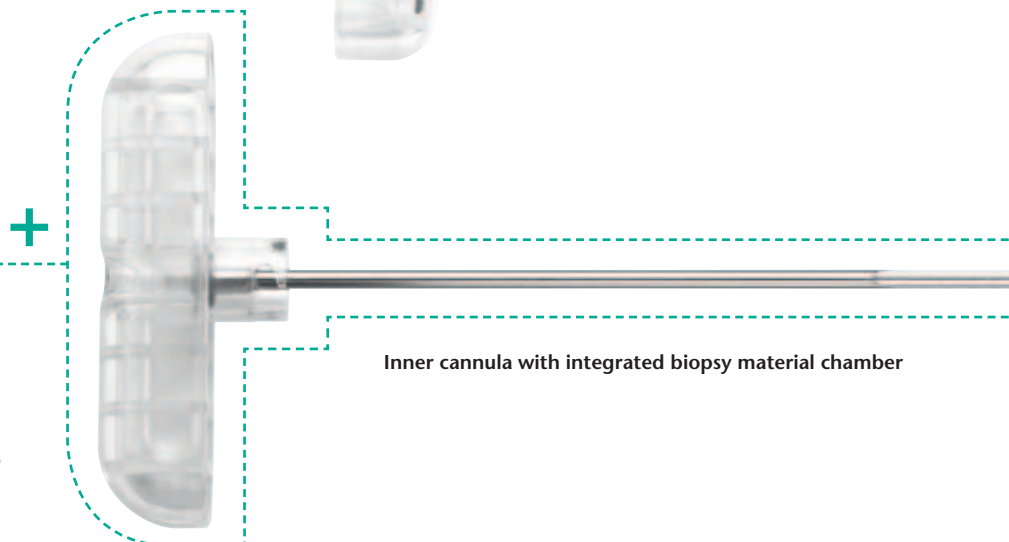

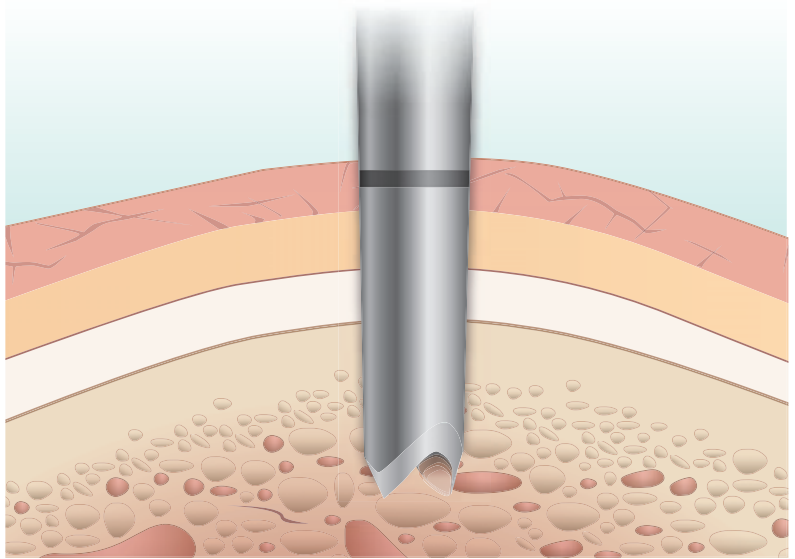

The outer cannula with its very sharp, wavelike tip penetrates the inside of the bone under rotary movements without problem.



Introductory aid

Ejection stylet with graduation



Integrated biopsy material chamber

## The safe lock

# TrokaCut with bayonet lock

The outer cannula is advanced together with the full stylet into the bone wall by turning clockwise and anticlockwise while applying firm and constant pressure. When it has penetrated and the resistance is reduced, the stylet is released from the bayonet lock, i.e. turned by 90° and pulled out. The outer cannula with its very sharp, wavelike tip continues to penetrate the inside of the bone under rotary movements without problem. The cannula tip is cylindrical and tapers towards the front. This eases collection and subsequent extraction of the sample. At the same time, its conical shape contributes to the tissue cylinder maintaining its structure during tissue extraction.

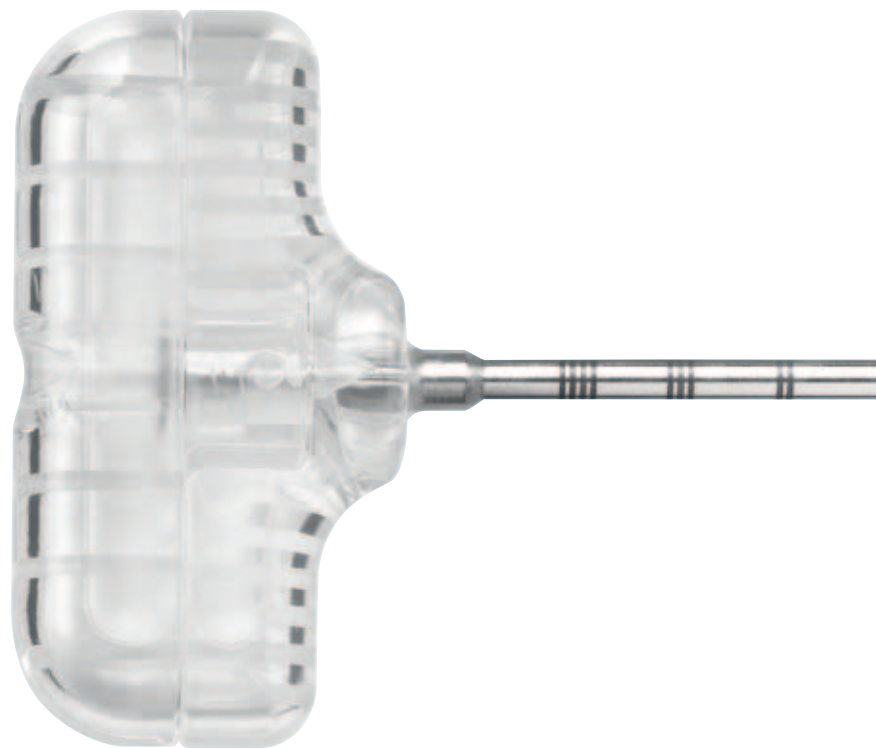

### **The essential features at a glance:**

- ➔ anatomically shaped handle
- ➔ extremely sharp serrated tip of the outer cannula
- ➔ full stylet made of stainless steel with high stability
- ➔ tapered outer cannula for simplified sample extraction
- ➔ safe sample extraction by specially shaped cannula shaft
- ➔ aspiration connection with LuerLock connector
- ➔ specially shaped internal lumen
- ➔ bayonet lock



**Bayonet lock**  
Full stylet and inner cannula are securely connected to the outer cannula using a bayonet lock.



**Cannula tip with sharp bevelled hollow grind**

➔ simplifies puncture of the pelvic crest in interaction with the rotary movements and pressure



**Sharp serrated tip of the outer cannula**

➔ enables continued penetration of the outer cannula in the inside of the bone after removal of the full stylet and collection of the bone marrow sample



**Inner cannula with integrated biopsy material chamber**

➔ additional biopsy safety and simple extraction

## TrokaBone

# The robust complete system with stainless steel connection

The TrokaBone puncture set of equipment from PAJUNK® consists of a modular system for the extraction of bone marrow samples. This set is very easy to use for puncture and aspiration. Fitted with an ergonomic handle and manufacturer in robust stainless steel, TrokaBone is characterised by its high level of stability.

### Single biopsy

The TrokaBone set includes a stable full stylet. This is optionally available with a bevelled hollow tip or trocar tip. The outer cannula and ejection stylet are both provided with a graduation. The introductory aid covers the sharp tip of the outer cannula when extracting biopsy material and so prevents injuries.

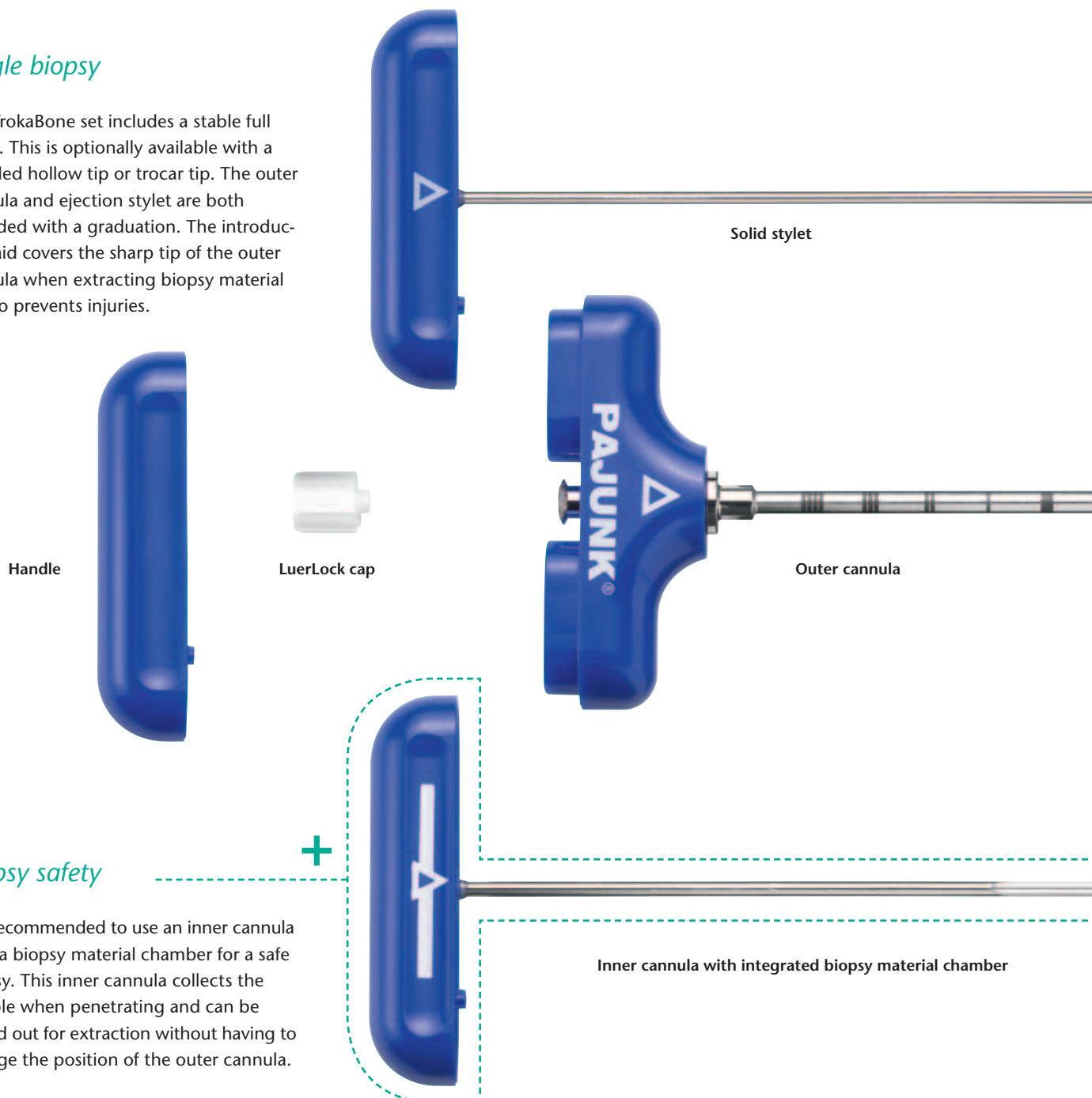

### Biopsy safety

It is recommended to use an inner cannula with a biopsy material chamber for a safe biopsy. This inner cannula collects the sample when penetrating and can be pulled out for extraction without having to change the position of the outer cannula.





Robust anchoring system made of metal with LuerLock connection.



Introductory aid

Ejection stylet with graduation



Integrated biopsy material chamber

## TrokaBone

# Biopsy cannula with alternative tip geometries

A bevelled tip or trocar tip is used to puncture at the pelvic crest.

The puncture cannula is advanced forward into the bone wall under clockwise / counter clockwise rotation while applying firm and constant pressure. When it has penetrated and the resistance is reduced, the stylet is pulled out. The outer cannula has a very sharp, serrated tip. The cannula continues to penetrate into the inside of the bone under rotary movements without problem. The cannula tip is cylindrical and tapers towards the front. This eases collection and subsequent extraction of the sample. At the same time, its conical shape contributes to the tissue cylinder maintaining its structure during tissue extraction.

### The essential features at a glance:

- anatomically shaped handle
- extremely sharp serrated tip of the outer cannula
- full stylet made of stainless steel with high stability
- cannula versions with bevelled tip, trocar tip and inner cannula
- tapered outer cannula for simplified sample extraction
- specially shaped internal lumen
- aspiration connection with LuerLock connector

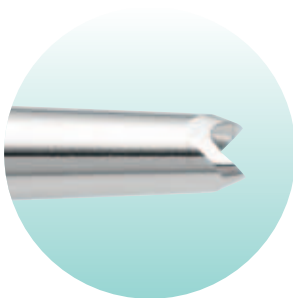
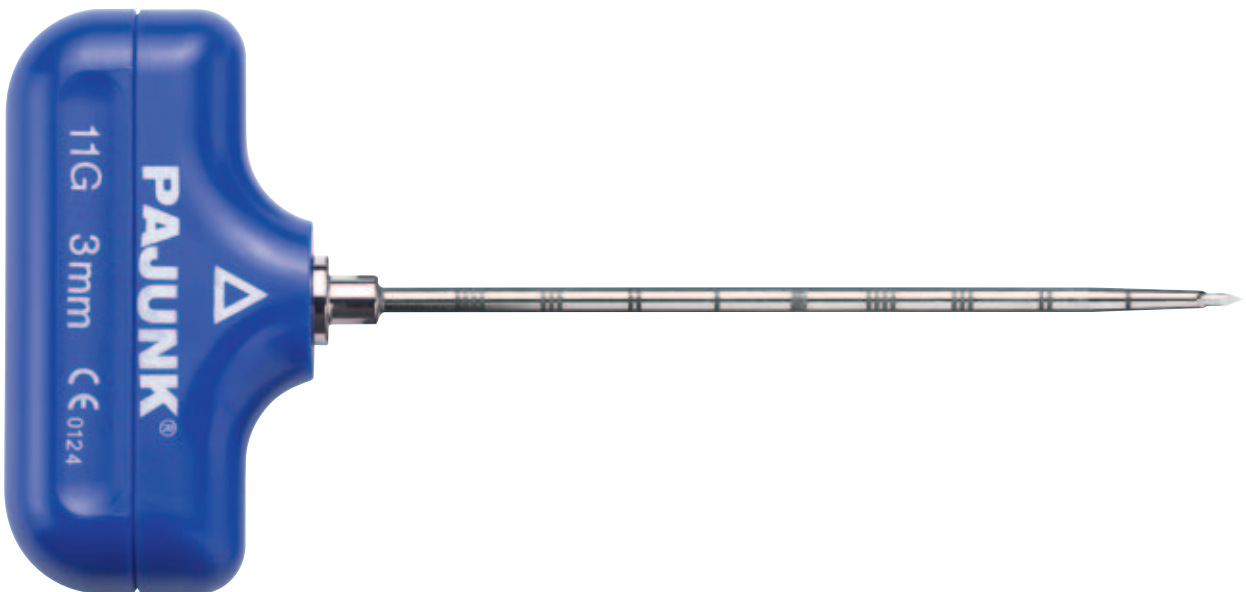

Tapered cannula tip,  
serrated tip



Cutting tip with bevelled  
hollow grind



Sharp tip with  
trocar grind

## TrokaBone Sternal

# Puncture set of equipment for single biopsy

TrokaBone Sternal was developed by PAJUNK® for simple and safe aspiration of bone marrow from the pelvic and sternum region.

The ergonomically shaped handle and the extremely sharp cannula tip guarantees ease of use during puncture and aspiration.

### The essential features at a glance:

- ➔ anatomically shaped handle
- ➔ extremely sharp cannula tip
- ➔ puncture cannula made of stainless steel with high stability
- ➔ safe sample extraction by specially shaped cannula shaft
- ➔ aspiration connection with LuerLock connector

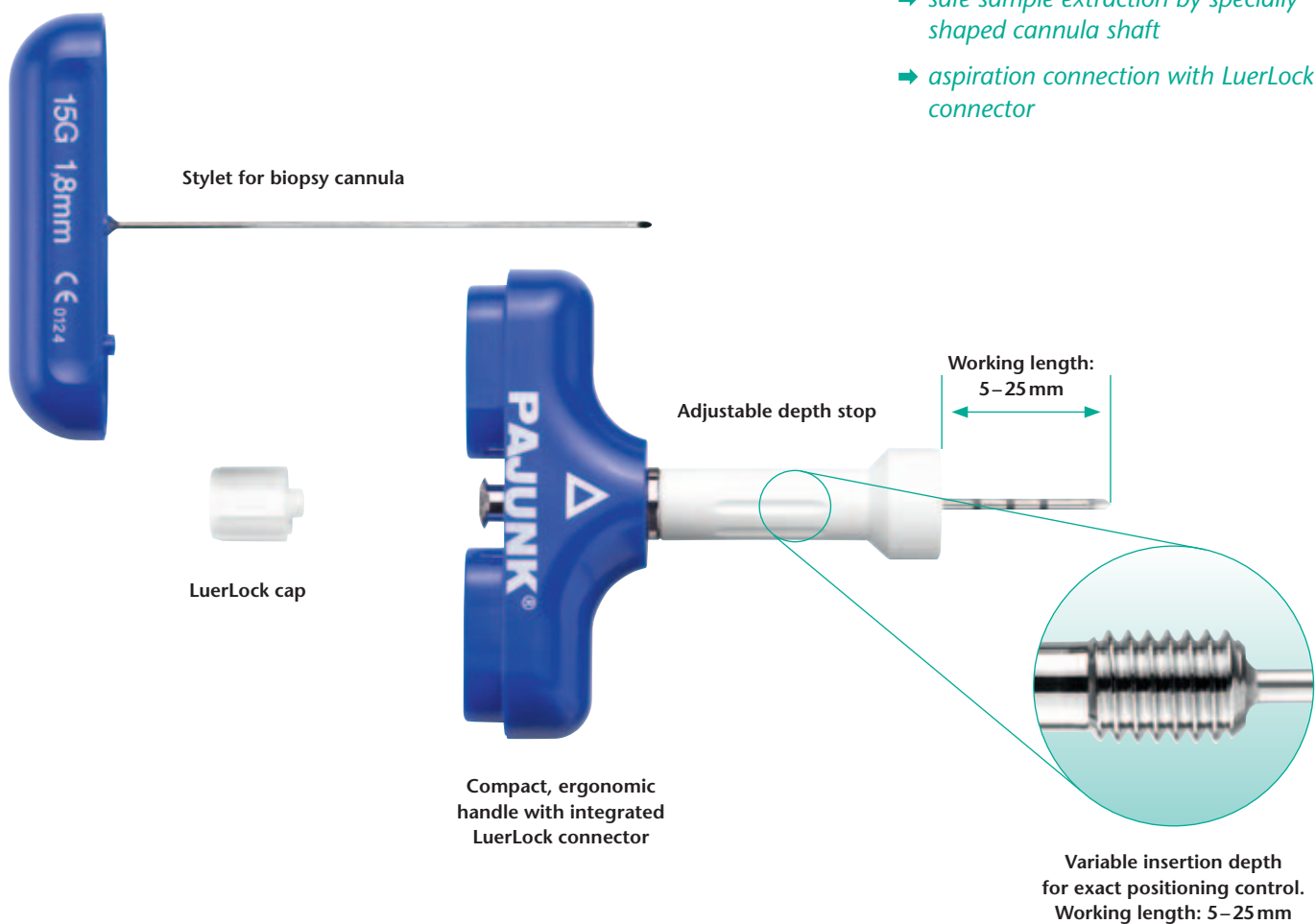

Cannula tip with sharp grind

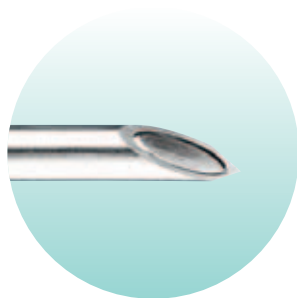

Precise fit grind between outer cannula and stylet

## TrokaCut

Product	Size	Art. No.	PU
Set for bone marrow biopsy with bevelled hollow tip	13 G x 100 mm (2.4mm)	1147-1C010	5
	11 G x 100 mm (3.0mm)	1147-1E010	5
	11 G x 150 mm (3.0mm)	1147-1E015	5
	8 G x 100 mm (4.0mm)	1147-1I010	5
	8 G x 150 mm (4.0mm)	1147-1I015	5
Set for bone marrow biopsy with bevelled hollow tip and inner cannula	11 G x 100 mm (3.0mm)	1147-6E010	5
	8 G x 100 mm (4.0mm)	1147-6I010	5

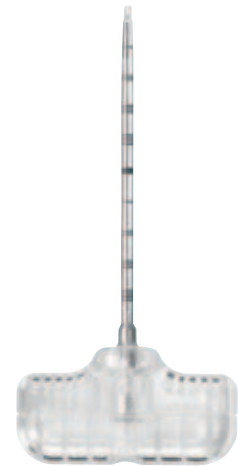

## TrokaBone

Product	Size	Bevelled hollow tip Trocar tip		PU
		Art. No.	Art. No.	
Set for bone marrow biopsy	13 G x 100 mm (2.4mm)	1145-1C010	1145-2C010	5
	11 G x 100 mm (3.0mm)	1145-1E010	1145-2E010	5
	11 G x 150 mm (3.0mm)	1145-1E015	1145-2E015	5
	8 G x 100 mm (4.0mm)	1145-1I010	1145-2I010	5
	8 G x 150 mm (4.0mm)	1145-1I015	1145-2I015	5
Set for bone marrow biopsy with inner cannula	11 G x 100 mm (3.0mm)	1145-6E010		5
	8 G x 100 mm (4.0mm)	1145-6I010		5



## TrokaBone Sternal

Working length 5–25 mm

Product	Size	Art. No.	PU
Set for bone marrow biopsy in sternum region	18 G x 50 mm (1.2mm)	1146-1D025	5
	17 G x 50 mm (1.5 mm)	1146-1G025	5
	15 G x 50 mm (1.8mm)	1146-1K025	5
	14 G x 50 mm (2.0mm)	1146-1M025	5



**PAJUNK GmbH**  
 Medizintechnologie  
 Karl-Hall-Strasse 1  
 D-78187 Geisingen/Germany  
 Telefon +49 (0) 77 04/92 91-0  
 Telefax +49 (0) 77 04/92 91-6 00  
 www.pajunk.com