

	<b>Seite</b>
	<b>Page</b>
<b>Inhaltsübersicht - Urologie</b>	
Table of contents - Urology	
<b>Zystoskopie</b>	<b>3-13</b>
Cystoscopy	
<b>Resektoskopie</b>	<b>14-22</b>
Resectoscopy	
<b>Urethroskopie</b>	<b>23-26</b>
Urethroscopy	
<b>Dünnes Resektoskop</b>	<b>27-31</b>
Thin Resectoscope	
<b>Uretero-Renoskopie</b>	<b>32-35</b>
Uretero-Renoscopy	
<b>Kinder Urologie</b>	<b>36-44</b>
Pediatric Urology	
<b>Zubehör</b>	<b>45-46</b>
Accessories	

# Zystoskopie Cystoscopy

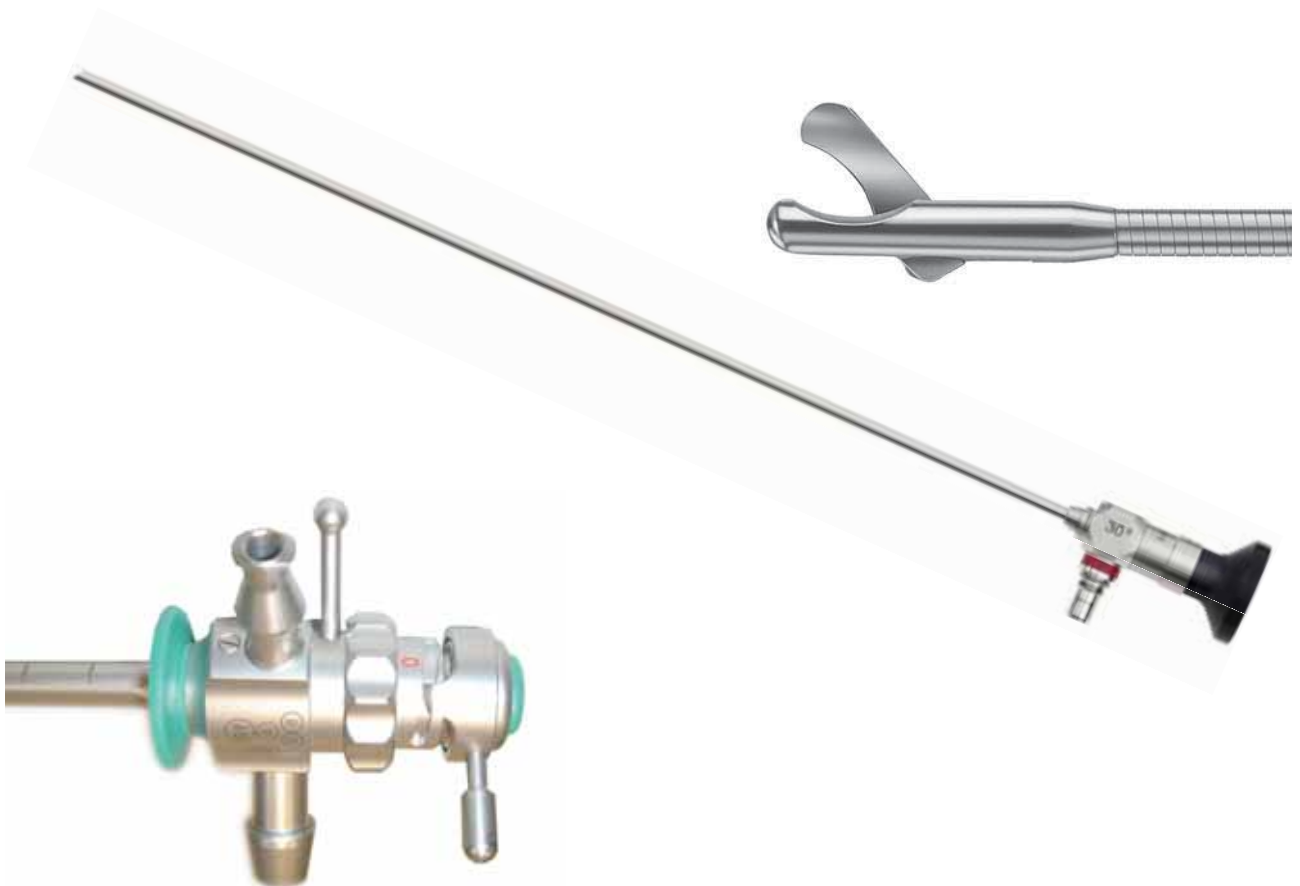

**Zystoskope**  
Cystoscopes

*stainless steel*

Sämtliche Optiken sind mit 3-teiligen Lichtleiteranschluss für alle üblichen Lichtleitkabel ausgestattet

All telescopes are equipped with 3 different light guide connectors for the most common cables

- ③ Storz®/Olympus®-Adapter
- ④ Wolf® Adapter
- ⑤ ACM® Anschluß / connector
- ⑥ Storz® Anschluß / connector
- ⑦ Okulartrichter / Eye piece

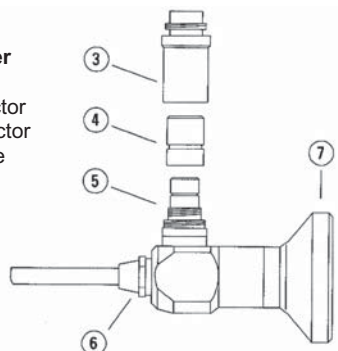

- 31-00094      **Zystoskop, 4mm, Blickrichtung 0°, 302 mm lang, autoklavierbar**
- 31-00095      **Zystoskop, 4mm, Blickrichtung 12°, 302 mm lang, autoklavierbar**
- 31-00096      **Zystoskop, 4mm, Blickrichtung 30°, 302 mm lang, autoklavierbar**

- 31-00094      Cystoscope, 4mm, straight forward 0°, 302 mm length autoclavable,
- 31-00095      Cystoscope, 4mm, forward-oblique 12°, 302 mm length, autoclavable,
- 31-00096      Cystoscope, 4mm, forward-oblique 30°, 302 mm length, autoclavable,

**Fiberlichtkabel**  
Fibre Light cables



**Fiber-Lichtleitkabel, autoklavierbar bei**

Fibre Light cables, autoclavable at 2,3 bar

Geräte-Adapter Equipment adapter	Endoskop-Adapter Endoscope adapter	Ø [mm]	Länge 1800 mm Length 1800 mm	Länge 2300 mm Length 2300 mm	Länge 3000 mm Length 3000 mm
REMA / Storz	REMA / Storz	4,8	31-00200	31-00201	31-00202
REMA / Storz	REMA / Storz	6,0	31-00205	31-00206	31-00207
Winter / Ibe	REMA / Storz	4,8	31-00210	31-00211	31-00212
Winter / Ibe	Winter / Ibe	6,0	31-00215	31-00216	31-00217
Wolf / HSW	Wolf / HSW	4,8	31-00220	31-00221	31-00222
Wolf / HSW	Wolf / HSW	6,0	31-00225	31-00226	31-00227
ACM / British	ACM / British	4,8	31-00230	31-00231	31-00232
ACM / British	ACM / British	6,0	31-00235	31-00236	31-00237

**Hochleistungslichtkabel für Lichtquellen mit hoher Leistung, autoklavierbar bei 2,3 bar (134°C)**

High Power Light cables for Light Sources with high performance, autoclavable at 2,3 bar (134°C)

Geräte-Adapter Equipment adapter	Endoskop-Adapter Endoscope adapter	Ø [mm]	Länge 1800 mm Length 1800 mm	Länge 2300 mm Length 2300 mm	Länge 3000 mm Length 3000 mm
REMA / Storz	REMA / Storz	4,8	31-00500	31-00501	31-00502
Winter / Ibe	REMA / Storz	4,8	31-00510	31-00511	31-00512
Wolf / HSW	Wolf / HSW	4,8	31-00520	31-00521	31-00522
ACM / British	ACM / British	4,8	31-00530	31-00531	31-00532

*stainless steel*

**Zystoskopie - Urethrokopieschäfte mit Obturator**  
Cystoscopy - Urethroscope sheaths with Obturator



**Zystoskop - Urethroskopschaft mit 2 starren Hähnen und Obturator**

**Cystoscope - Urethroscope sheath with 2 fixed stopcocks and Obturator**

26-02009	15 CH Kennfarbe Schwarz
26-02010	17 CH Kennfarbe Gelb
26-02011	19 CH Kennfarbe Grün
26-02012	21 CH Kennfarbe Rot
26-02013	23 CH Kennfarbe Blau
26-02014	25 CH Kennfarbe Weiss

26-02009	15 Fr. Colour code black
26-02010	17 Fr. Colour code yellow
26-02011	19 Fr. Colour code green
26-02012	21 Fr. Colour code red
26-02013	23 Fr. Colour code blue
26-02014	25 Fr. Colour code white



**Zystoskop - Urethroskopschaft mit Zentralhahn und Obturator**

**Cystoscope - Urethroscope sheath with Central valve and Obturator**

26-02003	17 CH Kennfarbe Gelb
26-02004	19 CH Kennfarbe Grün
26-02005	21 CH Kennfarbe Rot
26-02006	23 CH Kennfarbe Blau
26-02007	25 CH Kennfarbe Weiss

26-02003	17 Fr. Colour code yellow
26-02004	19 Fr. Colour code green
26-02005	21 Fr. Colour code red
26-02006	23 Fr. Colour code blue
26-02007	25 Fr. Colour code white



**Sichtobturatoren zur Verwendung mit Cystoskop / Urethroskop**

**Visual obturator for use with Cystoscope / Urethroscope**

26-02040	17 CH Kennfarbe Gelb
26-02041	19 CH Kennfarbe Grün
26-02042	21 CH Kennfarbe Rot
26-02043	23 CH Kennfarbe Blau
26-02044	25 CH Kennfarbe Weiss

26-02040	17 Fr. Colour code yellow
26-02041	19 Fr. Colour code green
26-02042	21 Fr. Colour code red
26-02043	23 Fr. Colour code blue
26-02044	25 Fr. Colour code white

**Untersuchungseinsätze**  
Telescope - bridges

*stainless steel*



26-02023

**Zysto- / Urethroskopie-Adapter für weibliches Urethroskop**

26-02023

Cysto- / Urethroscopy adapter for female Urethroscope



26-02030

**Albarraneinsatz mit Umlenkhebel und einem Arbeitskanal**

26-02030

Albarran working element with deflector and one working channel

26-02031

**Albarraneinsatz mit Umlenkhebel und zwei Arbeitskanälen**

26-02031

Albarran working element with deflector and two working channels

Schaft mit Obturator Sheath with obturator		Kennfarbe Color code	Durchlass mit Arbeitseinsatz Passage with working element		Durchlass mit Untersuchungseinsatz Passage with Telescope bridge	
			26-02030	26-02031	26-02021	26-02022
26-02010	17 CH / Fr.	gelb/yellow	-	-	1x5 CH/FR	1x5 CH/FR
		gelb/yellow	-	-	-	-
26-02011	19 CH / Fr.	grün/green	1x5 CH/FR	1x5 CH/FR	1x6 CH/FR	1x6 CH/FR
		grün/green	-	2x4 CH/FR	-	2x5 CH/FR
26-02012	21 CH / Fr.	rot/red	1x6 CH/FR	1x6 CH/FR	1x7 CH/FR	1x7 CH/FR
		rot/red	-	2x5 CH/FR	-	2x6 CH/FR
26-02013	23 CH / Fr.	blau/blue	1x9 CH/FR	1x9 CH/FR	1x10 CH/FR	1x10 CH/FR
		blau/blue	-	2x6 CH/FR	1 CH/FR	2x7 CH/FR
26-02014	25 CH / Fr.	weiß/white	1x10 CH/FR	1x10 CH/FR	1x12 CH/FR	1x12 CH/FR
		weiß/white	-	2x8 CH/FR	-	2x9 CH/FR

**Untersuchungseinsätze**  
Telescope - bridges

*stainless steel*



26-02020

**Untersuchungseinsatz für Diagnostik ohne Arbeitskanal**

26-02020

Telescope bridge for diagnostic without working channel



26-02021

**Untersuchungseinsatz mit einem Arbeitskanal**

26-02021

Telescope bridge with one working channel



26-02022

**Untersuchungseinsatz mit zwei Arbeitskanälen**

26-02022

Telescope bridge with two working channels

Optische Instrumente  
Optical Instruments

*stainless steel*

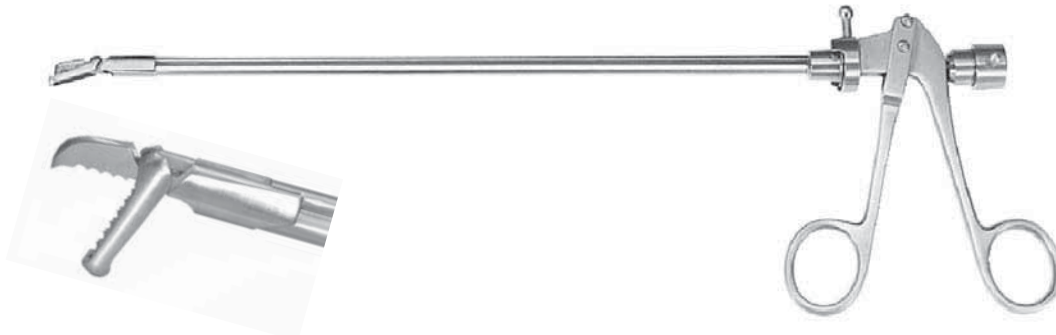

26-02051

**Steinfasszange,  
doppelbeweglich**



26-02051

Stone grasping forceps,  
double action jaws

26-02052

**Hakenschere,  
doppelbeweglich**



26-02052

Hook scissors,  
double action jaws

26-02053

**Löffelfasszange,  
doppelbeweglich**



26-02053

Spoon grasping forceps,  
double action jaws

26-02054

**Biopsiestanze,  
doppelbeweglich**



26-02054

Biopsy punch,  
double action jaws

26-02055

**Steinzertrümmerer**



26-02055

Stone forceps

26-02056

**Fasszange von unten,  
doppelbeweglich**



26-02056

Grasping forceps from bottom,  
double action jaws

26-02057

**Biopsiezange mit kurzen Maul-  
teilen 2,3 mm f. 30° Optik  
beidseitig öffnend**



26-02057

Biopsy forceps with short jaw  
parts 2,3 mm for 30° Optic  
double action jaws



Isolierter Schaft auf Anfrage  
Insulated sheath on request

40 cm Arbeitslänge  
40 cm working length



26-00621	Biopsiezange, doppelbeweglich 10 CH	26-00621	Biopsy forceps, double action jaw 10 Fr.
26-00622	Biopsiezange, doppelbeweglich, halbstarr 10 CH	26-00622	Biopsy forceps, double action jaw, semi rigid, 10 Fr.
26-00610	Biopsiezange, doppelbeweglich 7 CH	26-00610	Biopsy forceps, double action jaw 7 Fr.
26-00623	Biopsiezange, doppelbeweglich, halbstarr 7 CH	26-00623	Biopsy forceps, double action jaw, semi rigid, 7 Fr.
26-00618	Biopsiezange, doppelbeweglich 5 CH	26-00618	Biopsy forceps, double action jaw 5 Fr.
26-00624	Biopsiezange, doppelbeweglich, halbstarr 5 CH	26-00624	Biopsy forceps, double action jaw, semi rigid, 5 Fr.
26-00625	Biopsiezange, doppelbeweglich 3 CH	26-00625	Biopsy forceps, double action jaw 3 Fr.
26-00626	Biopsiezange, doppelbeweglich, halbstarr 3 CH	26-00626	Biopsy forceps, double action jaw, semi rigid, 3 Fr.
26-00601	Fasszange, doppelbeweglich 7 CH	26-00601	Grasping forceps, double action jaw 7 Fr.
26-00627	Fasszange, doppelbeweglich, halbstarr 7 CH	26-00627	Grasping forceps, double action jaw, semi rigid, 7 Fr.
26-00615	Fasszange, doppelbeweglich 5 CH	26-00615	Grasping forceps, double action jaw 5 Fr.
26-00628	Fasszange, doppelbeweglich, halbstarr 5 CH	26-00628	Grasping forceps, double action jaw, semi rigid, 5 Fr.





**Isolierter Schaft auf Anfrage**  
**Insulated sheath on request**

**40 cm Arbeitslänge**  
 40 cm working length



26-00629	<b>Schere, einfachbeweglich</b> <b>10 CH</b>	26-00629	Scissors, single action jaw 10 Fr.
26-00630	<b>Schere, einfachbeweglich,</b> <b>halbstarr 10 CH</b>	26-00630	Scissors, single action jaw, semi rigid, 10 Fr.
26-00631	<b>Schere, einfachbeweglich</b> <b>7 CH</b>	26-00631	Scissors, single action jaw 7 Fr.
26-00632	<b>Schere, einfachbeweglich,</b> <b>halbstarr 7 CH</b>	26-00632	Scissors, single action jaw, semi rigid, 7 Fr.
26-00612	<b>Schere, einfachbeweglich</b> <b>5 CH</b>	26-00612	Scissors, single action jaw 5 Fr.
26-00633	<b>Schere, einfach beweglich,</b> <b>halbstarr 5 CH</b>	26-00633	Scissors, single action jaw, semi rigid, 5 Fr.



26-00634	<b>Hakenschere,</b> <b>einfachbeweglich 10 CH</b>	26-00634	Hook scissors, single action jaw 10 Fr.
26-00635	<b>Hakenschere,</b> <b>einfachbeweglich 7 CH</b>	26-00635	Hook scissors, single action jaw 7 Fr.



26-00636	<b>Schere, doppelbeweglich</b> <b>7 CH</b>	26-00636	Scissors, double action jaw 7 Fr.
----------	---	----------	--------------------------------------



**Isolierter Schaft auf Anfrage**  
**Insulated sheath on request**

**40 cm Arbeitslänge**  
 40 cm working length

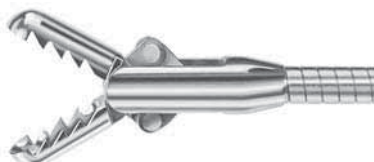

26-00637	<b>Ovaler Löffel, Wellenschliff</b> 10 CH	26-00637	Oval cup, serrated 10 Fr.
26-00638	<b>Ovaler Löffel, Wellenschliff,</b> halbstarr 10 CH	26-00638	Oval cup, serrated, semi rigid 10 Fr.
26-00639	<b>Ovaler Löffel, Wellenschliff</b> 7 CH	26-00639	Oval cup, serrated 7 Fr.
26-00640	<b>Ovaler Löffel, Wellenschliff,</b> halbstarr 7 CH	26-00640	Oval cup, serrated, semi rigid 7 Fr.
26-00641	<b>Ovaler Löffel, Wellenschliff</b> 5 CH	26-00641	Oval cup, serrated 5 Fr.
26-00642	<b>Ovaler Löffel, Wellenschliff,</b> halbstarr 5 CH	26-00642	Oval cup, serrated, semi rigid, 5 Fr.



26-00643	<b>Ovaler Löffel, Wellenschliff</b> 7 CH	26-00643	Oval cup, serrated 7 Fr.
----------	---	----------	-----------------------------



26-00644	<b>Biopsiezange,</b> einfachbeweglich 7 CH	26-00644	Biopsy forceps, single action jaws 7 Fr.
----------	---	----------	---



26-00645	<b>Fasszange,</b> einfachbeweglich 7 CH	26-00645	Grasping forceps, single action jaws 7 Fr.
----------	--	----------	---

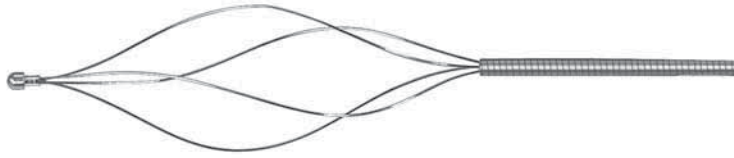

26-00648

**Steinfänger 3 CH,  
Länge 60 cm**

26-00648

Stone basket 3 Fr.,  
length 60 cm

26-00649

**Steinfänger 3 CH,  
Länge 120 cm**

26-00649

Stone basket 3 Fr.,  
length 120 cm

26-00650

**Steinfänger 5 CH,  
Länge 60 cm**

26-00650

Stone basket 5 Fr.,  
length 60 cm

# *Resektoskopie*

## *Resectoscopy*



**Arbeitselemente (für 4,0mm/302mm/0°/30° Optik)**  
Working elements (for 4,0mm/302mm/0°/30° optics)

nicht in Deutschland lieferbar



26-02102

Arbeitselement, passiv,  
aus Edelstahl

26-02102

Working element, passive,  
stainless steel

nicht in Deutschland lieferbar



26-02112

Arbeitselement, aktiv,  
aus Edelstahl

26-02112

Working element, active,  
stainless steel

**Monopolare Elektroden mit einem Führungsrohr**  
Unipolar Electrodes single stem



26-02202	<b>Schlingenelektrode, gerade</b> 24 CH	26-02202	Loop electrode, straight 24 Fr.
----------	--	----------	------------------------------------

26-02219	<b>Schlingenelektrode, gerade</b> 27 CH	26-02219	Loop electrode, straight 27 Fr.
----------	--	----------	------------------------------------



26-02200	<b>Schlingenelektrode 30° gebogen, 24 CH</b>	26-02200	Loop electrode curved 30° 24 Fr.
----------	--	----------	-------------------------------------

26-02220	<b>Schlingenelektrode 30° gebogen, 27 CH</b>	26-02220	Loop electrode curved 30° 27 Fr.
----------	--	----------	-------------------------------------



26-02221	<b>Schlingenelektrode 90° gebogen, 24 CH</b>	26-02221	Loop electrode curved, 90° 24 Fr.
----------	--	----------	--------------------------------------

26-02222	<b>Schlingenelektrode 90° gebogen, 27 CH</b>	26-02222	Loop electrode curved, 90° 27 Fr.
----------	--	----------	--------------------------------------



26-02204	<b>Kugelelektrode 3 mm, 24 CH</b>	26-02204	Ball electrode 3 mm, 24 Fr.
----------	-----------------------------------	----------	--------------------------------

26-02223	<b>Kugelelektrode 3 mm, 27 CH</b>	26-02223	Ball electrode 3 mm, 27 Fr.
----------	-----------------------------------	----------	--------------------------------



26-02205	<b>Kugelelektrode 5 mm, 24 CH</b>	26-02205	Ball electrode 5 mm, 24 Fr.
----------	-----------------------------------	----------	--------------------------------

26-02224	<b>Kugelelektrode 5 mm, 27 CH</b>	26-02224	Ball electrode 5 mm, 27 Fr.
----------	-----------------------------------	----------	--------------------------------

Farbkennung: gelb = 24 CH, braun = 27 CH

Colour code: yellow = 24 Fr., brown = 27 Fr.

**Monopolare Elektroden mit einem Führungsrohr**  
Unipolar Electrodes single stem



26-02206	<b>Rollenelektrode 3 mm, 24 CH</b>	26-02206	Roller electrode 3 mm, 24 Fr.
26-02225	<b>Rollenelektrode 3 mm, 27 CH</b>	26-02225	Roller electrode 3 mm, 27 Fr.



26-02207	<b>Rollenelektrode 5 mm, 24 CH</b>	26-02207	Roller electrode 5 mm, 24 Fr.
26-02226	<b>Rollenelektrode 5 mm, 27 CH</b>	26-02226	Roller electrode 5 mm, 27 Fr.



26-02217	<b>Vaporisationselektrode 3 mm, 24 CH</b>	26-02217	Vaporisation electrode 3 mm, 24 Fr.
26-02227	<b>Vaporisationselektrode 3 mm, 27 CH</b>	26-02227	Vaporisation electrode 3 mm, 27 Fr.



26-02218	<b>Vaporisationselektrode 5 mm, 24 CH</b>	26-02218	Vaporisation electrode 5 mm, 24 Fr.
26-02228	<b>Vaporisationselektrode 5 mm, 27 CH</b>	26-02228	Vaporisation electrode 5 mm, 27 Fr.

Farbkennung: gelb = 24 CH, braun = 27 CH

Colour code: yellow = 24 CH, brown = 27 CH



**Monopolare Elektroden mit einem Führungsrohr**  
Unipolar Electrodes single stem



26-02215	<b>Spike-Elektrode 3 mm, 24 CH</b>	26-02215	Spike electrode 3 mm, 24 Fr.
26-02229	<b>Spike-Elektrode 3 mm, 27 CH</b>	26-02229	Spike electrode 3 mm, 27 Fr.



26-02216	<b>Spike-Elektrode 5 mm, 24 CH</b>	26-02216	Spike electrode 5 mm, 24 Fr.
26-02230	<b>Spike-Elektrode 5 mm, 27 CH</b>	26-02230	Spike electrode 5 mm, 27 Fr.



26-02208	<b>Kegelelektrode 3 mm, 24 CH</b>	26-02208	Conical electrode 3 mm, 24 Fr.
26-02231	<b>Kegelelektrode 3 mm, 27 CH</b>	26-02231	Conical electrode 3 mm, 27 Fr.



26-02203	<b>Messerelektrode gebogen, 24 CH</b>	26-02203	Knife electrode curved, 24 Fr.
26-02232	<b>Messerelektrode gebogen, 27 CH</b>	26-02232	Knife electrode curved, 27 Fr.



26-02233	<b>Bandeletrode, 0° Optik 24 CH</b>	26-02233	Band electrode, 0° Optic 24 Fr.
26-02234	<b>Bandeletrode, 0° Optik 27 CH</b>	26-02234	Band electrode, 0° Optic 27 Fr.

Farbkennung: gelb = 24 CH, braun = 27 CH

Colour code: yellow = 24 Fr., brown = 27 Fr.

**Monopolare Elektroden mit einem Führungsrohr**  
Unipolar Electrodes single stem



26-02235	<b>Bandelektrode, 30° Optik 24 CH</b>	26-02235	Band electrode, 30° Optic 24 Fr.
----------	---	----------	-------------------------------------

26-02236	<b>Bandelektrode, 30° Optik 27 CH</b>	26-02236	Band electrode, 30° Optic 27 Fr.
----------	---	----------	-------------------------------------



26-02237	<b>Bandelektrode, Vaporisation 24 CH</b>	26-02237	Band electrode, vaporisation 24 Fr.
----------	--	----------	--

26-02228	<b>Bandelektrode, Vaporisation 27 CH</b>	26-02228	Band electrode, vaporisation 27 Fr.
----------	--	----------	--

Farbkennung: gelb = 24 CH, braun = 27 CH

Colour code: yellow = 24 Fr., brown = 27 Fr.



26-02240	<b>Sterilisationsbehälter für Elektroden</b>	26-02240	Sterilization box for electrodes
----------	--	----------	----------------------------------



26-02250	<b>HF-Kabel für Aesculap, Berchtold, Martin, 4 mm</b>	26-02250	HF cable for Aesculap, Berchtold, Martin, 4 mm
----------	---	----------	---



26-02251	<b>HF-Kabel für Storz, Erbe, 5 mm</b>	26-02251	HF cable for Storz, Erbe, 5 mm
----------	---------------------------------------	----------	--------------------------------



26-02252	<b>HF-Kabel für Valleylab, Bowie, 8 mm</b>	26-02252	HF cable for Valleylab, Bowie, 8 mm
----------	--	----------	--

**Resektoskopschäfte mit *feststehendem* Innenschaft zur Dauerspülung**  
 Resectoscope sheaths with *fixed* inner sheat for continuous flow



**Außenschaft mit Rundloch Rundumperforation**  
 Outer sheath with round-hole all-round perforation



**Außenschaft mit Langloch Rundumperforation**  
 Outer sheath with long-hole all-round perforation



26-02120	<b>Resektoskopschaft komplett für Dauerspülung (bestehend aus: Außenschaft mit Rundloch, Innenschaft und Obturator), 26 CH feststehend -&gt; passend für Elektroden mit 24 CH</b>	26-02120	Resectoscope sheath complete for continuous flow (consisting of: Outer sheath with round-hole , inner sheath and obturator), 26 Fr., fixed -> suitable for electrodes with 24 FR
26-02142	<b>Außenschaft mit Rundloch Rundumperforation für Absaugung, 26 CH, feststehend</b>	26-02142	Outer sheath with round-hole all-round perforation for suction, 26 Fr., fixed
26-02152	<b>Außenschaft mit Langloch Rundumperforation für Absaugung, 26 CH, feststehend</b>	26-02152	Outer sheath with long-hole all-round perforation for suction, 26 Fr.; fixed
26-02122	<b>Innenschaft mit Keramik-isolation, 24 / 26 CH, feststehend</b>	26-02122	Inner sheath with ceramic insulation, 24 / 26 Fr, fixed
26-02117	<b>Standard Obturator für 24 / 26CH</b>	26-02117	Standard obturator for 24 / 26 Fr.
26-02140	<b>Resektoskopschaft komplett für Dauerspülung (bestehend aus: Außenschaft mit Rundloch, Innenschaft und Obturator), 27 / 28,5 CH, feststehend -&gt; passend für Elektroden mit 27 CH</b>	26-02140	Resectoscope sheath complete for continuous flow (consisting of: Outer sheath with round-hole , inner sheath and obturator), 27 / 28,5 Fr, fixed -> suitable for electrodes with 27 FR
26-02143	<b>Außenschaft mit Rundloch Rundumperforation für Absaugung, 28,5 CH, feststehend</b>	26-02143	Outer sheath with round-hole all-round perforation for suction, 28,5 Fr, fixed
26-02144	<b>Innenschaft mit Keramik-isolation, 27 CH, feststehend</b>	26-02144	Inner sheath with ceramic insulation, 27 Fr., fixed
26-02118	<b>Standard Obturator für 27 / 28,5 CH</b>	26-02118	Standard obturator for 27 / 28,5 Fr.

**Resektoskopschäfte mit *drehbarem* Innenschaft zur Dauerspülung**  
 Resectoscope sheaths with *rotatable* inner sheath for continuous flow



**Außenschaft mit Rundloch Rundumperforation**  
 Outer sheath with round-hole all-round perforation



**Außenschaft mit Langloch Rundumperforation**  
 Outer sheath with long-hole all-round perforation



26-02121	<b>Resektoskopschaft komplett für Dauerspülung (bestehend aus: Außenschaft mit Rundloch, Innenschaft und Obturator), 24 / 26 CH, drehbar</b> -> passend für Elektroden mit 24 CH	26-02121	Resectoscope sheath complete for continuous flow (consisting of: Outer sheath with round-hole , inner sheath and obturator), 24 / 26 Fr., rotatable -> suitable for electrodes with 24 FR
26-02153	<b>Außenschaft mit Rundloch Rundumperforation für Absaugung, 26 CH, drehbar</b>	26-02153	Outer sheath with round-hole all-round perforation for suction, 26 Fr., rotatable
26-02125	<b>Außenschaft mit Langloch Rundumperforation, für Absaugung, 26 CH, drehbar</b>	26-02125	Outer sheath with long-hole all-round perforation for suction, 26 Fr., rotatable
26-02124	<b>Innenschaft mit Keramik-isolation, 24 / 26 CH drehbar</b>	26-02124	Inner sheath with ceramic insulation, 24 / 26 Fr., rotatable
26-02117	<b>Standard Obturator für 24 / 26 CH</b>	26-02117	Standard obturator for 24 / 26 Fr.
26-02141	<b>Resektoskopschaft komplett für Dauerspülung (bestehend aus: Außenschaft mit Rundloch, Innenschaft und Obturator), 27 / 28,5 CH, drehbar</b> -> passend für Elektroden mit 27 CH	26-02141	Resectoscope sheath complete for continuous flow (consisting of: Outer sheath with round-hole , inner sheath and obturator),, 27 / 28,5 Fr., rotatable -> suitable for electrodes with 27 FR
26-02150	<b>Außenschaft mit Rundloch Rundumperforation für Absaugung, 28,5 CH, drehbar</b>	26-02150	Outer sheath with round-hole all-round perforation for suction, 28,5 Fr, rotatable
26-02154	<b>Außenschaft mit Langloch Perforation oben für Absaugung 28,5 CH, drehbar</b>	26-02154	Outer sheath with long-hole perforation up for suction, 28,5 Fr., rotatable
26-02151	<b>Innenschaft mit Keramik-isolation, 27 / 28,5 CH drehbar</b>	26-02151	Inner sheath rotatable with ceramic insulation, 27 / 28,5 Fr.
26-02118	<b>Standard Obturator für 28,5 CH</b>	26-02118	Standard obturator for 28,5 Fr.

**Resectoscopschäfte**  
Resectoscope sheath



26-02146	<b>Resektoscopschaft mit Zentralhahn ohne Obturator, 24 CH</b>	26-02146	Resectoscope sheath with central valve without obturator, 24 Fr.
----------	--	----------	--

26-02147	<b>Resektoscopschaft mit Zentralhahn ohne Obturator, 27 CH</b>	26-02147	Resectoscope sheath with central valve without obturator, 27 Fr.
----------	--	----------	--



26-02148	<b>Resektoscopschaft mit 1 Hahn, ohne Obturator, 24 CH</b>	26-02148	Resectoscope sheath without obturator, 1 stopcock, 24 Fr.
----------	--	----------	---

26-02149	<b>Resektoscopschaft mit 1 Hahn, ohne Obturator, 27 CH</b>	26-02149	Resectoscope sheath 27 Fr. 1 stopcock, without obturator,
----------	--	----------	---

**Obturatoren**  
Obturator



26-02130	<b>Beweglicher Obturator, 24 / 26 CH</b>	26-02130	Flexible obturator, 24 / 26 Fr.
----------	--	----------	---------------------------------

26-02131	<b>Beweglicher Obturator, 27 / 28,5 CH</b>	26-02131	Flexible obturator, 27 / 28,5 Fr.
----------	--	----------	-----------------------------------



26-02117	<b>Standardobturator, 24 / 26 CH</b>	26-02117	Standard obturator, 24 / 26 Fr.
----------	--------------------------------------	----------	---------------------------------

26-02118	<b>Standardobturator, 27 / 28,5 CH</b>	26-02118	Standard obturator, 27 / 28,5 Fr.
----------	--	----------	-----------------------------------



26-02135	<b>Sichtobturator, 24 / 26 CH</b>	26-02135	Visual obturator, 24 / 26 Fr.
----------	-----------------------------------	----------	-------------------------------

26-02136	<b>Sichtobturator, 27 / 28,5 CH</b>	26-02136	Visual obturator, 27 / 28,5 Fr.
----------	-------------------------------------	----------	---------------------------------



26-02137	<b>Sichtobturator 24 / 26 CH mit 1 Instrumentenkanal, Arbeitskanal 5 CH</b>	26-02137	Visual obturator 24 / 26 Fr. with 1 working channel, working channel 5 Fr.
----------	---	----------	--

26-02138	<b>Sichtobturator 27 / 28,5 CH mit 1 Instrumentenkanal, Arbeitskanal 7 CH</b>	26-02138	Visual obturator 27 / 28,5 Fr. with 1 working channel, Working channel 7 Fr.
----------	---	----------	--

# *Urethrotoskopie*

## *Urethrotoscopy*



**Arbeitselemente (für 4,0mm/302mm/0°/30° Optik)**  
Working elements (for 4,0mm/302mm/0°/30° optics)

*nicht in Deutschland lieferbar*



26-02102

Arbeitselement, passiv,  
aus Edelstahl

26-02102

Working element, passive,  
stainless steel

**Urethrotomschäfte**  
Urethrotom sheaths



26-02400	<b>Urethrotomschafft 21 CH mit Instrumentenkanal 5 CH ohne Obturator</b>	26-02400	Urethrotom sheath 21 Fr. with instrument channel 5 Fr. without obturator
----------	--	----------	--



26-02403	<b>Zusatzschafft, seitlich offen zum Legen eines Ballonkatheters, seitlich aufschiebbar auf 26-02400</b>	26-02403	Additional sheath sidewise open for laying of a balloon catheter, sidewise deferrable on 26-02400
----------	--	----------	---



26-02404	<b>Urethrotom Außenschafft mit 1 Hahn zur Dauerspülung</b>	26-02404	Outer Urethrotom sheath with 1 tap for continuous flow
----------	--	----------	--

**Obturatoren für Urethrotomschäfte (für Erwachsene/0° Optik/4mm,302mm)**  
Obturator for Urethrotome sheaths (for adults/0° Optics/4mm,302mm)



26-02401	<b>Standardobturator für Schaft 21 CH</b>	26-02401	Standard obturator for sheath 21 Fr.
----------	---	----------	--------------------------------------



26-02405	<b>Hohlobturator für 5 CH Instrumentenkanal</b>	26-02405	obturator concave for instrument channel 5 Fr.
----------	---	----------	--







26-02407	<b>Sichtobturator, für Urethrotom</b>	26-02407	Visual obturator, for Urethrotome
----------	---------------------------------------	----------	-----------------------------------



26-02408	<b>Optikbrücke, für Urethrotom</b>	26-02408	Visual bridge, for Urethrotome
----------	------------------------------------	----------	--------------------------------



**Messer für Urethrotomie (für Erwachsene/0° Optik/4mm,302mm)**  
 Cold knives for Urethrotomy (for adults/0°Optics/4mm,302mm)

26-02410	Strikturmesser gerade		26-02410	Cold knife, straight
26-02411	Striktur-Rundmesser		26-02411	Cold knife, round
26-02412	Strikturmesser gerade mit Wellenschliff		26-02412	Cold knife, straight, serrated
26-02413	Strikturmesser ringförmig		26-02413	Cold knife, circular
26-02414	Striktur-Hakenmesser		26-02414	Cold knife, hook-shaped

# *dünnes Resektoskop* *thin Resectoscope*



**Arbeitselemente (für 2,9mm/302mm/0°/30° Optik)**  
Working elements (for 2,9mm/302mm/0°/30° optics)

*nicht in Deutschland lieferbar*



26-02450

Arbeitselement passiv

26-02450

Working element passive

*nicht in Deutschland lieferbar*



26-02451

Arbeitselement aktiv

26-02451

Working element active

## Zystoskop Cystoscope

Sämtliche Optiken sind mit einem 3-teiligen Lichtleiteranschluss für alle üblichen Lichtleitkabel ausgestattet

All telescopes are equipped with 3 different light guide connectors for the most common cables

- ③ Storz®/Olympus®-Adapter
- ④ Wolf® Adapter
- ⑤ ACM® Anschluß / connector
- ⑥ Storz® Anschluß / connector
- ⑦ Okulartrichter / Eye piece

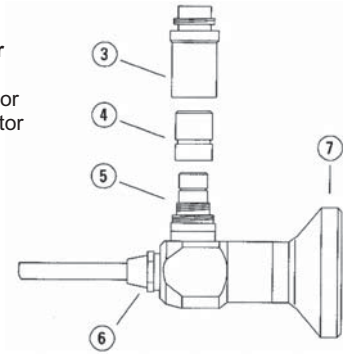

31-00067      **Hysteroskop, 2,7mm,  
Blickrichtung 30°,  
302 mm lang, autoklavierbar**

31-00067      Hysteroscope, 2,7mm,  
straight forward 30°,  
302 mm length autoclavable

31-00069      **Hysteroskop, 2,9mm,  
Blickrichtung 30°,  
302 mm lang, autoklavierbar**

31-00069      Hysteroscope, 2,9mm,  
straight forward 30°,  
302 mm length autoclavable

**New**

**New**

**Resektoskopschaft (19/22 CH für 2,9mm/12° Optik)**  
 Resectoscope sheath (19/22 CH for 2,9mm/12° optics)



26-02460	<b>Resektoskopschaft 19 CH ohne Obturator</b>	26-02460	Resectoscope sheath 19 Fr. without obturator
26-02461	<b>Standardobturator für 19 CH Schaft</b>	26-02461	Standard obturator for 19 Fr. sheath

**Sichtobturatoren (19/22 CH für 2,9mm/12° Optik)**  
 Visual obturators (19/22 CH for 2,9mm/12° optics)



26-02462	<b>Dauerspülschaft komplett, starr, ohne Obturator, 19 CH / 22 CH -&gt; passend für Elektroden mit 19 CH</b>	26-02462	Sheath for continuous flow complete, rigid, without obturator, 19 Fr. / 22 Fr. -> suitable for electrodes with 19 FR
26-02463	<b>Außenschaft mit Perforation für Absaugung, 22 CH</b>	26-02463	Outer sheath with perforation for suction, 22 Fr.
26-02464	<b>Innenschaft starr mit Keramikisolation, 19 CH</b>	26-02464	Inner sheath rigid with ceramic insulation, 19 Fr.
26-02465	<b>Standard Obturator für 19 CH</b>	26-02465	Standard obturator for 19 Fr.
<b>Ohne Abbildung:</b>		<b>Without illustration:</b>	
26-02466	<b>Dauerspülschaft, drehbar, ohne Obturator, 19 CH / 22 CH -&gt; passend für Elektroden mit 19 CH</b>	26-02466	Sheath for continuous flow, rotatable, without obturator, 19 Fr. / 22 Fr. -> suitable for electrodes with 19 FR
26-02467	<b>Außenschaft mit Perforation für Absaugung, 22 CH</b>	26-02467	Outer sheath with perforation for suction, 22 Fr.
26-02468	<b>Innenschaft drehbar mit Keramikisolation, 19 CH</b>	26-02468	Inner sheath rotatable with ceramic insulation, 19 Fr.
26-02469	<b>Standard Obturator für 19 CH</b>	26-02469	Standard obturator for 19 Fr.

**Sichtobturatoren (19/22 CH für 2,9mm/12° Optik)**  
 Visual obturators (19/22 CH for 2,9mm/12° optics)



26-02470	<b>Sichtobturator, 19/22 CH</b>	26-02470	Visual obturator, 19/22 Fr.
----------	---------------------------------	----------	-----------------------------

**Monopolare Elektroden mit einem Führungsrohr (19/22 CH für 2,9mm/12° Optik)**  
 Unipolar Electrodes single stem (19/22 CH for 2,9mm/12° optics)



26-02480

**Schlingenelektrode,  
19 CH**

26-02480

Loop electrode,  
19 Fr.



26-02481

**Schlingenelektrode gebogen,  
19 CH**

26-02481

Loop electrode curved,  
19 Fr.



26-02482

**Kugelelektrode 3 mm,  
19 CH**

26-02482

Ball electrode 3 mm,  
19 Fr.



26-02483

**Rollenelektrode 3 mm,  
19 CH**

26-02483

Roller electrode 3 mm  
19 Fr.



26-02484

**Messerelektrode gebogen,  
19 CH**

26-02484

Knife electrode curved,  
19 Fr.

# *Uretero-Renoskopie*

## *Uretero-Renoscopy*

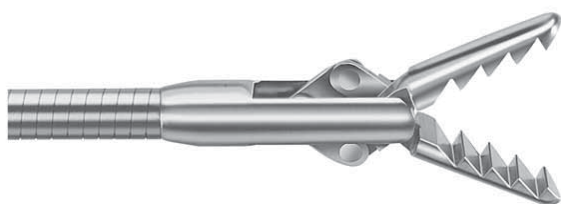

**REMA Uretero-Renoscope sind eine Neuentwicklung mit perfekter Sicht und praktischem Design**  
**REMA Uretero-renoscopes are a new development with a perfect view and practical design**

*autoclavable*



**31-00130 Uretero-Renoskop,  
 Durchmesser 8 CH / 9,8 CH  
 Arbeitskanal 5 CH,  
 Länge 315 mm**

**31-00130 Uretero-Renoscope  
 diameter 8 Fr. / 9,8 Fr.  
 working channel 5 Fr.,  
 length 315 mm**

**31-00131 Uretero-Renoskop  
 Durchmesser 8 CH / 9,8 CH  
 Arbeitskanal 5 CH  
 Länge 430 mm**

**31-00131 Uretero-Renoscope  
 diameter 8 Fr. / 9,8 Fr.  
 working channel 5 Fr.  
 length 430 mm**

*autoclavable*



**31-00132 Uretero-Renoskop Schrägeinblick  
 Durchmesser 8 CH / 9,8 CH  
 Arbeitskanal 5 CH,  
 Länge 315 mm**

**31-00132 Uretero-Renoscope angular insight  
 diameter 8 Fr. / 9,8 Fr.  
 working channel 5 Fr.  
 length 315 mm**

**31-00133 Uretero-Renoskop Schrägeinblick  
 Durchmesser 8 CH / 9,8 CH  
 Arbeitskanal 5 CH,  
 Länge 430 mm**

**31-00133 Uretero-Renoscope angular insight  
 diameter 8 Fr. / 9,8 Fr.  
 working channel 5 Fr.  
 length 430 mm**



**Fasszangen für Steine und Fremdkörper, flexible, halbstarr mit und ohne Feder**  
 Grasping forceps for stones and fragments, flexible, semi-rigid with or without spring

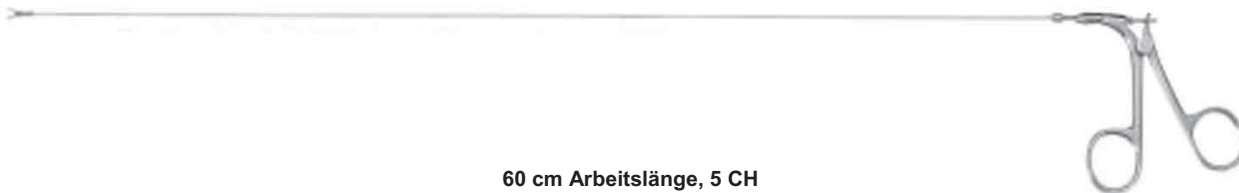

60 cm Arbeitslänge, 5 CH  
 60 cm working length, 5 Fr.



26-00651	Fasszange, flexibel, ohne Feder	26-00651	Grasping forceps, flexible, without spring
26-00652	Fasszange, flexibel, mit Feder	26-00652	Grasping forceps, flexible, with spring
26-00653	Fasszange, halbstarr, ohne Feder	26-00653	Grasping forceps, semi-rigid, without spring
26-00654	Fasszange, halbstarr, mit Feder	26-00654	Grasping forceps, semi-rigid, with spring



26-00655	Fasszange, flexibel, ohne Feder	26-00655	Grasping forceps, flexible, without spring
26-00656	Fasszange, flexibel, mit Feder	26-00656	Grasping forceps, flexible, with spring
26-00657	Fasszange, halbstarr, ohne Feder	26-00657	Grasping forceps, semi-rigid, without spring
26-00658	Fasszange, halbstarr, mit Feder	26-00658	Grasping forceps, semi-rigid, with spring



26-00659	Fasszange, flexibel, ohne Feder	26-00659	Grasping forceps, flexible, without spring
26-00660	Fasszange, flexibel, mit Feder	26-00660	Grasping forceps, flexible, with spring
26-00661	Fasszange, halbstarr, ohne Feder	26-00661	Grasping forceps, semi-rigid, without spring
26-00662	Fasszange, halbstarr, mit Feder	26-00662	Grasping forceps, semi-rigid, with spring

**Fasszangen für Steine und Fremdkörper, flexible, halbstarr mit und ohne Feder**  
 Grasping forceps for stones and fragments, flexible, semi-rigid with or without spring



**60 cm Arbeitslänge, 5 CH**  
 60 cm working length, 5 Fr.

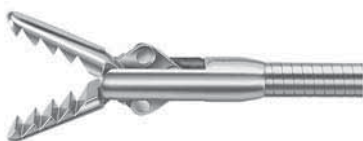

26-00616	<b>Fasszange, flexibel, ohne Feder</b>	26-00616	Grasping forceps, flexible, without spring
26-00663	<b>Fasszange, flexibel, mit Feder</b>	26-00663	Grasping forceps, flexible, with spring
26-00664	<b>Fasszange, halbstarr, ohne Feder</b>	26-00664	Grasping forceps, semi-rigid, without spring
26-00665	<b>Fasszange, halbstarr, mit Feder</b>	26-00665	Grasping forceps, semi-rigid, with spring

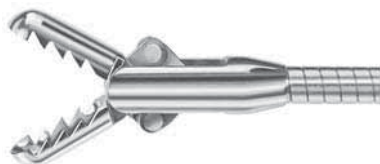

26-00666	<b>Fasszange, flexibel, ohne Feder</b>	26-00666	Grasping forceps, flexible, without spring
26-00667	<b>Fasszange, flexibel, mit Feder</b>	26-00667	Grasping forceps, flexible, with spring
26-00668	<b>Fasszange, halbstarr, ohne Feder</b>	26-00668	Grasping forceps, semi-rigid, without spring
26-00669	<b>Fasszange, halbstarr, mit Feder</b>	26-00669	Grasping forceps, semi-rigid, with spring

# *Kinder Urologie* *Paediatric Urology*



**Zystoskope - Cystoscopes**

*stainless steel*

Sämtliche Optiken sind mit einem 3-teiligen Lichtleiteranschluss für alle üblichen Lichtleitkabel ausgestattet

All telescopes are equipped with 3 different light guide connectors for the most common cables

- Storz®/Olympus®-Adapter
- Wolf® Adapter
- ACM® Anschluß / connector
- Storz® Anschluß /

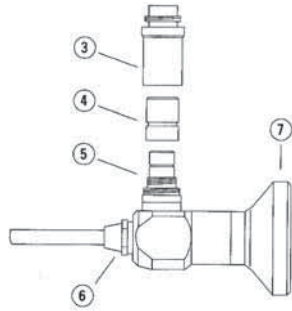

**31-00093.1**      **Zystoskop, 2,7 mm, Blickrichtung 0°, 187,5 mm lang, autoklavierbar**

**31-00092**      **Cystoscope, 2,7 mm, straight forward 0°, 302 mm length autoclavable,**

**31-00093.2**      **Zystoskop, 2,7 mm, Blickrichtung 30°, 187,5 mm lang, autoklavierbar**

**31-00093**      **Cystoscope, 2,7 mm, forward-oblique 30°, 302 mm length, autoclavable,**

**Fiberlichtkabel**  
Fibre Light cables



**Fiber-Lichtleitkabel, autoklavierbar bei 2,3 bar (134°C)**

Fibre Light cables, autoclavable at 2,3 bar (134°C)

Geräte-Adapter Equipment adapter	Endoskop-Adapter Endoscope adapter	Ø [mm]	Länge 1800 mm Length 1800 mm	Länge 2300 mm Length 2300 mm	Länge 3000 mm Length 3000 mm
REMA / Storz	REMA / Storz	4,8	31-00200	31-00201	31-00202
REMA / Storz	REMA / Storz	6,0	31-00205	31-00206	31-00207
Winter / Ibe	REMA / Storz	4,8	31-00210	31-00211	31-00212
Winter / Ibe	Winter / Ibe	6,0	31-00215	31-00216	31-00217
Wolf / HSW	Wolf / HSW	4,8	31-00220	31-00221	31-00222
Wolf / HSW	Wolf / HSW	6,0	31-00225	31-00226	31-00227
ACM / British	ACM / British	4,8	31-00230	31-00231	31-00232
ACM / British	ACM / British	6,0	31-00235	31-00236	31-00237

**Hochleistungslichtkabel für Lichtquellen mit hoher Leistung, autoklavierbar bei 2,3 bar (134°C)**

High Power Light cables for Light Sources with high performance, autoclavable at 2,3 bar (134°C)

Geräte-Adapter Equipment adapter	Endoskop-Adapter Endoscope adapter	Ø [mm]	Länge 1800 mm Length 1800 mm	Länge 2300 mm Length 2300 mm	Länge 3000 mm Length 3000 mm
REMA / Storz	REMA / Storz	4,8	31-00500	31-00501	31-00502
Winter / Ibe	REMA / Storz	4,8	31-00510	31-00511	31-00512
Wolf / HSW	Wolf / HSW	4,8	31-00520	31-00521	31-00522
ACM / British	ACM / British	4,8	31-00530	31-00531	31-00532

**Arbeitselemente (für 2,7mm/187mm/0° Optik)**  
Working elements (for 2,7mm/187mm/0° optics)

*nicht in Deutschland lieferbar*



26-02600

**Arbeitselement, passiv,  
aus Titan und rostfreiem  
Stahl**

26-02600

Working element, passive,  
Titanium and  
stainless steel made



26-02602

**Standard Schaft 13 CH  
ohne Obturator**

26-02602

Standard sheath 13 Fr.  
without obturator



26-02603

**Obturator 13 CH**

26-02603

Obturator 13 Fr.



26-02604

**Cystoschaft mit 1 Kanal, 13 CH  
Arbeitskanal 5 CH ohne  
Obturator**

26-02604

**Cysto sheath with 1 channel, 13 Fr.  
working channel 5 Fr. without  
obturator**



26-02605

**Obturator für Cystoschaft, 13 CH**

26-02605

**Obturator for cysto sheath , 13 Fr.**



26-02606

**Arbeitseinsatz mit  
Albaran-Hebel für 13 CH**

26-02606

**Working insert with Albaran lever  
for 13 Fr.**



26-02607

**Optikbrücke 13 CH**

26-02607

**Optical bridge 13 Fr.**



26-02560

Schlingenelektrode, klein 13 CH

26-02560

Loop electrode, small 13 Fr.



26-02561

Schlingenelektrode, groß 13 CH

26-02561

Loop electrode, big 13 Fr.



26-02562

Kugelelektrode 13 CH

26-02562

Ball electrode 13 Fr.



26-02563

Messerelektrode 13 CH

26-02563

Knife electrode 13 Fr.



26-02608

Urethrotomschaft inkl.  
Standardobturator 13 CH

26-02608

Urethrotome sheath incl.  
standard obturator 13 Fr.



26-02609

Obturator für Urethrotomschaft  
13 CH

26-02609

Obturator for Urethrotome sheath  
13 Fr.





26-02610

**Untersuchungseinsatz mit  
Kanal 13 CH  
Arbeitskanal 5 CH**

26-02610

Diagnostic sheath with 1 channel  
13 Fr.  
working channel 5 Fr.



26-02613

**Strikturmesser gerade 13 CH**

26-02613

Cold knife, straight 13 Fr.



26-02614

**Strikturmesser, rund 13 CH**

26-02614

Cold knife, round 13 Fr.



26-02615

**Strikturmesser, hakenförmig  
13 CH**

26-02615

Cold knife, hook shape 13 Fr.



26-02616

**Strikturmesser, sichelförmig  
13 CH**

26-02616

Cold knife, sickle shape 13 Fr.



26-02617

**Cystoschaft mit 1 Kanal, 11 CH  
Arbeitskanal 3 CH  
ohne Obturator**

26-02617

Cysto sheath with 1 channel, 11 Fr.  
working channel 3 Fr.  
without obturator



26-02618

Obturator für Cystoschaft, 11 CH

26-02618

Obturator for cysto sheath , 11 Fr.



26-02619

Standard Schaft 11 CH  
ohne Obturator

26-02619

Standard sheath 11 Fr.  
without obturator



26-02620

Obturator 11 CH

26-02620

Obturator 11 Fr.



26-02621

Schlingenelektrode, klein 11 CH

26-02621

Loop electrode, small 11 Fr.



26-02622

Schlingenelektrode, groß 11 CH

26-02622

Loop electrode, big 11 Fr.



26-02623

Kugelelektrode 11 CH

26-02623

Ball electrode 11 Fr.



26-02624

Messerelektrode 11 CH

26-02624

Knife electrode 11 Fr.



26-02626

Urethrotomschaft inkl.  
Standardobturator 11 CH

26-02626

Urethrotome sheath incl.  
standard obturator 11 Fr.



26-02627

Obturator für Urethrotomschaft  
11 CH

26-02627

Obturator for Urethrotome sheath  
11 Fr.



26-02628

Strikturmesser gerade  
11 CH

26-02628

Cold knife, straight  
11 Fr.



26-02629

Strikturmesser, rund  
11 CH

26-02629

Cold knife, round  
11 Fr.



26-02630

Strikturmesser, hakenförmig  
11 CH

26-02630

Cold knife, hook shape  
11 Fr.



26-02631

Strikturmesser, sichelförmig  
11 CH

26-02631

Cold knife, sickle shape  
11 Fr.

# Zubehör Accessories



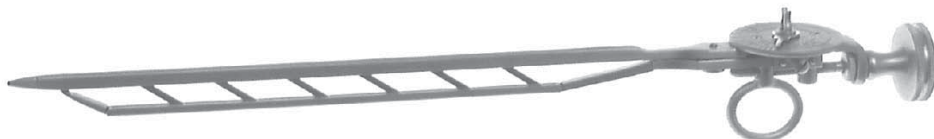
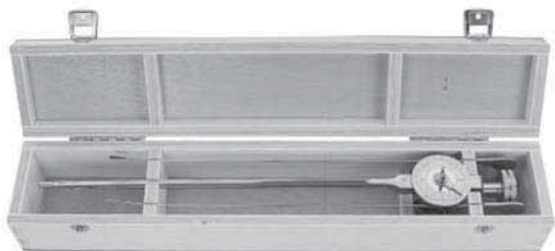

26-02512 **Otis Urethrotom mit 3 Wechselklingen, in Holzschachtel**

26-02512 **Otis Urethrotom with 3 exchangeable knives in wooden box**



26-02513 **Ersatzklinge, gerade**

26-02513 **Spare blade, straight**

26-02514 **Ersatzklinge, gebogen**

26-02514 **Spare blade, curved**

26-02515 **Ersatzklingen, kugelförmig**

26-02515 **Spare blade, spherical**

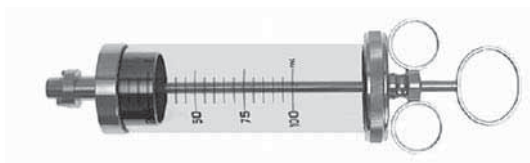

26-02517 **Record Spritze 50 ml**

26-02517 **Record Syringe 50 ml**

26-02518 **Record Spritze 75 ml**

26-02518 **Record Syringe 75 ml**

26-02519 **Record Spritze 100 ml**

26-02519 **Record Syringe 100 ml**

26-02520 **Record Spritze 150 ml**

26-02520 **Record Syringe 150 ml**



26-02500 **Evakuator (nach Ellik) bestehend aus: 26-02502 ,26-02504 , 26-02505**

26-02500 **Evacuator (Ellik) consist of: 26-02502 ,26-02504 , 26-02505**

26-02502 **Konus mit Schlauch**

26-02502 **Cone with tube**

26-02504 **Glaskugel**

26-02504 **Glass bowl**

26-02505 **Gummibalg**

26-02505 **Rubber bulb**

26-02510 **Luer-lock Anschluß**

26-02510 **Luer-lock connector**

26-02511 **Luer-lock Anschluß mit Hahn**

26-02511 **Luer-lock connector with stopcock**