

MEGAprogress

Valid as from 01.12.2008

BLANCO CS GmbH + Co KG
MEDICAL CARE SYSTEMS
P. O. Box 13 10
75033 Oberderdingen, Germany
Phone +49 7045 44-81900
Fax +49 7045 44 -81135
med@blanco.de
www.blanco.de

BLANCO

BLANCO

1

01.12.2008

Stainless-steel table tops

Table top model MTP

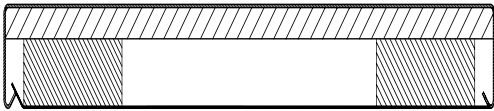

Smooth worktop made of 1.25 mm CNS 18/10, material 1.4301, ground 320 grain and brushed to satin finish, turned down 40 mm on all sides. The underside is fitted with V 20 particle board for noise insulation and also reinforced with an all-round frame. Panelled with CNS at front. Max. length of a table top 3,850 mm continuous, extendable with screw joint.

CNS 18/10

Item No.	Depth mm	Thickness mm
MC0001	up to 650	40
MC0003	up to 850	40

Table top model MTPB

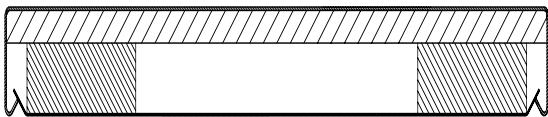

Smooth worktop made of 1.25 mm CNS 18/10, material 1.4301, ground 320 grain and brushed to satin finish, turned down 40 mm on all sides. The underside is fitted with V 20 particle board for noise insulation and also reinforced with an all-round frame. Underside smooth panelled with CNS metal sheet over entire surface. Max. length of a table top 3,850 mm continuous, extendable with screw joint.

CNS 18/10

Item No.	Depth mm	Thickness mm
MC0005	up to 650	40
MC0007	up to 850	40

Stainless-steel table tops

Corner table top

without screw joint, without vertical shelf

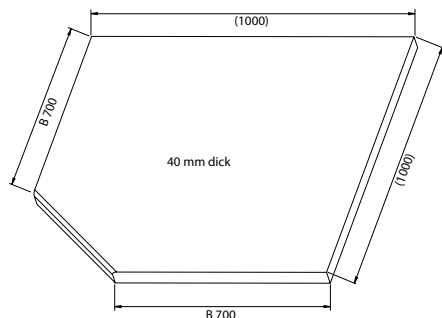

CNS 18/10

Item No.	Width mm	Depth mm	Description
MC0145	1000	1000	Model MTP, with depth of 700 mm
MC0146	1000	1000	Model MTPB, with depth of 700 mm

Accessories stainless-steel table tops

Screw joint

for CNS table tops

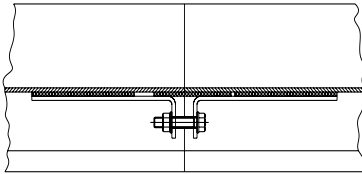

Item No.

580130

Profile edge for model MTP/MTPB

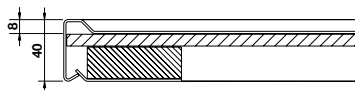

CNS 18/10

Item No.	Height mm
MC0028	8

Vertical shelf Z 40/20

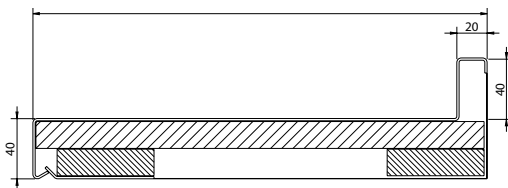

CNS 18/10

Item No.	Description
MC0030	rear
MC0031	on 2 sides
MC0032	on 3 sides

Accessories stainless-steel table tops

Vertical shelf CNS Z 40/20, shortened

shortened at front, on one side

Item No.

MC0099

Vertical shelf CNS Z 150/20, on one side

Item No.

MC0098

Rounded front edge, 10 mm radius for CNS table top

Added price per panel

CNS 18/10

Item No.

MC0147

Fitting hole

for 28 - 35 mm dia.

	Item No.	Diameter mm
	MC0029	28 - 35

Table top hole

with CNS panelling (MTP)

Item No.

MC0103

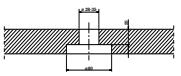
Accessories stainless-steel table tops

Table top cut-out

Item No.	Description
MC0100	L-shaped pillars mounted on wall
MC0101	L-shaped pillars mounted on front
MC0102	U-shaped pillars mounted on wall

Indented, grooved surface

of CNS 18/10

CNS 18/10

Item No.	Width mm	Depth mm	Description
MC0033	600	400	without incline
MC0034	600	400	with incline

Measuring marks for plaster bench

Item No.
MC0035

Cut-out for with mount for ultrasound basin

incl. hole pattern for switch panel, in base cabinet

Item No.
MC0036

Accessories stainless-steel table tops

Ventilation grate for CNS table top punched in

CNS

	Item No.
	538331

Fill-level marking of weld-in basin

Item No.
MC0097

Weld-in basins

Weld-in basin (only in conjunction with stainless-steel table tops) Stainless-steel basin

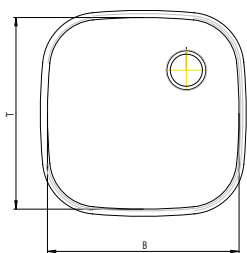

CNS 18/10

Item No.	Width mm	Depth mm	Height mm	Description
MC0081	240	340	150	Drain at rear right or left, 1 ½"
MC0082	240	370	150	Drain at rear right or left, 1 ½"
MC0085	300	500	300	Drain at rear right or left, 1 ½"
MC0090	370	340	150	Drain at rear right or left, 1 ½"
200454	400	400	200	Drain at rear right or left (reversible), 1 ½"
MC0083	400	400	250	Drain at rear right or left, 1 ½"
MC0084	400	400	300	Drain at rear right or left, 1 ½"
MC0142	500	400	250	Drain at rear right or left, 1 ½"
MC0086	500	400	300	Drain at rear right or left, 1 ½"
MC0087	500	500	250	Drain at rear right or left, 1 ½"
MC0088	500	500	300	Drain at rear right or left, 1 ½"
MC0089	500	500	350	Drain at rear right or left, 1 ½"

Note:

When installing the weld-in basin in MTBP stainless-steel table tops plus basin cut-out and sealing.

Weld-in basins

Weld-in basin (only in conjunction with stainless-steel table tops) Stainless-steel basin

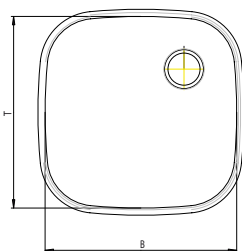

CNS 18/10

Item No.	Width mm	Depth mm	Height mm	Description
602254	600	400	250	Hand-welded Drain at rear left, 1 1/2"
602253	600	400	250	Hand-welded Drain at rear right, 1 1/2"
MC0250	600	450	250	Drain at left or right, 1 1/2"
MC0143	600	450	300	Drain at right or left, 1 1/2"
MC0091	600	500	250	Drain at rear right or left, 1 1/2"
MC0092	600	500	300	Drain at rear right or left, 1 1/2"
MC0093	600	600	300	Drain at rear right or left, 1 1/2"
MC0094	700	600	300	Drain at rear right or left, 1 1/2"
MC0095	750	560	400	Drain at rear left, 1 1/2"

Note:

When installing the weld-in basin in MTBP stainless-steel table tops plus basin cut-out and sealing.

Weld-in basins

Hand-washing basins

Drain in centre, 1 ½"

CNS 18/10

	Item No.	Width mm	Depth mm	Height mm
	MC0096	500	300	150

Weld-in basin, round

without overflow, discharge in rear centre 1 ½", basin size 385 dia. x 165 mm

CNS 18/10

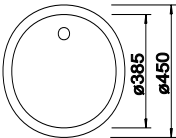
	Item No.	Width mm	Depth mm	Height mm
	511407	450	450	165

Infant weld-in tub

Drain at rear right, 1 ½"

CNS 18/10

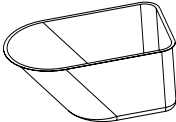
	Item No.	Width mm	Depth mm	Height mm
	233746	720	420	300

Note:

When installing the weld-in basin in MTBP stainless-steel table tops plus basin cut-out and sealing.

Cover for weld-in basin

adjusted to basin size

CNS 18/10

Item No.	Description
549580	with handles, double-walled with rubber seal
249581	with handles
248274	with grip hole

Hospital drain

Hospital drain

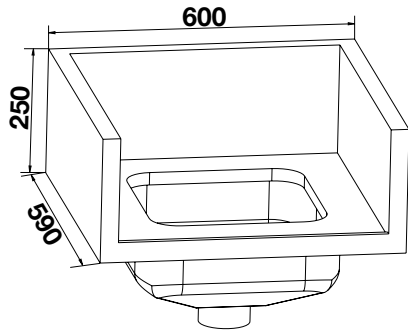

Table top made of CNS 18/10 with profile edge at front and welded-in utility sink 400 x 400 x 200 mm, drain opening with edge rinsing, 345 x 345 mm, including 3-sided splash wall, with side panelling, incl. swingaway support rack, with edge rinsing

CNS 18/10

Item No.	Width mm	Depth mm	Height mm	Description
542545	600	590	250	Model MAB 6 x 6 NW 70, with edge rinsing
542515	600	590	250	Model MAB 6 x 6 NW 100, with edge rinsing
542546	600	690	250	Model MAB 6 x 7 NW 70, with edge rinsing
542516	600	690	250	Model MAB 6 x 7 NW 100, with edge rinsing

Hospital drain, special

rear vertical shelf upward bevelling 80 mm, for mounting a vertical fitting

CNS 18/10

Item No.

MC0104

Moulding drain onto cover

Item No.

MC0040

Hospital drain

Odour trap for hospital drain

Model MAB 6 x 6 and model MAB 6 x 7, adjustable, NW 70

Item No.

137830

Odour trap for hospital drain

Model MAB 6 x 6 and model MAB 6 x 7, adjustable, NW 100

Item No.

232044

Tank/pump system, model ATT

Design "N", according to DIN 1988, standard program with approx. 6 ltr. rinsing volume for hospital drain

Item No.

245673

Resopal table tops

Table top model MTPK



Worktop post-forming, 0.8 mm thick Resopal coated, with rounded-off front edge, radius 10 mm. Max. length of a table top 3,050 mm continuous.

Resopal

Item No.	Depth mm	Thickness mm
541025007	600	40
541025008	700	40
541025009	800	40

Corner table top model MTPK-E

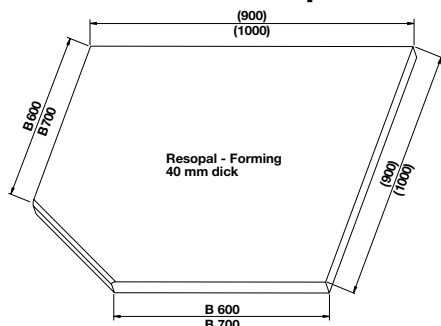

Corner table top post-forming, 0.8 mm thick Resopal coated, with rounded-off front edge, radius 10 mm.

Resopal

Item No.	Depth mm	Thickness mm
54102510	600	40
54102511	700	40

Accessories for Resopal table tops

Edge design on side (edge strip)

for MTPK table top, once per table-top unit

Item No.
MC0105

Vertical shelf

for wood/synthetic table tops placed on

Resopal

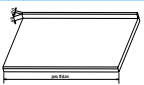
	Item No.	Depth mm	Height mm
	MC0041	20	40

Butt joint

for wood/synthetic table top

	Item No.
	541047

Corner butt joint

for wood/synthetic table top

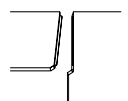
	Item No.
	MC0136

Accessories for Resopal table tops

Fitting hole

for 28 - 35 mm dia.

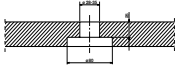
	Item No.
	MC0043

Ventilation grate for wood/synthetic table top

glued in, aluminium, silver-coloured

Aluminium

	Item No.
	543018

Cable bushing

for wood/synthetic table top

Item No.
MC0045

Basin cut-out

for build-in basins, hobs, ventilation grate milled areas and pillar/column cut-out in wood/synthetic table top

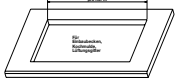



	Item No.
	MC0042

Build-in basins

Single build-in basin

without overflow indentation

CNS 18/10

	Item No.	Width mm	Depth mm	Height mm	Description
	531425	860	435	150	EES 8 x 4, build-in sink Basin size: 340 x 370 x 150 mm Cut-out dimensions: 842 x 417 mm without overflow 1 1/2" drain
	502821	330	470	150	EE 3 x 4 Basin size: 240 x 340 x 150 mm Cut-out dimensions: 310 x 450 mm 1 1/2" drain
	531282	435	470	150	EE 4 x 4 Basin size: 340 x 370 x 150 mm Cut-out dimensions: 415 x 450 mm 1 1/2" drain
	536136	450	450	165	RONDO Basin size: 385 dia. x 165 mm Cut-out dimensions: 432 mm dia. 1 1/2" drain
	531298	500	500	200	EE 5 x 5-4.2 Basin size: 400 x 400 x 200 mm Cut-out dimensions: 480 x 480 mm 1 1/2" drain
	531299	500	500	300	EE 5 x 5-4.3 Basin size: 400 x 400 x 300 mm Cut-out dimensions: 480 x 480 mm Drain at rear left, 1 1/2"

Sold via:

Christine Meyer
 Berliner Str. 26
 57290 Neunkirchen
 Phone +49 2735 6199875
 Fax +49 2735 6199876
 E-mail: cmeyer.neunkirchen@web.de

Build-in basins

Infant build-in tub

Table top cut-out, 800 x 500 mm

Tub dimension: 720 x 420 x 300 mm

Total dimensions: 820 x 520 mm

CNS 18/10

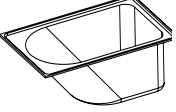
	Item No.
	533888

Accessories for stainless-steel basins

Synthetic drain valve

	Item No.	Description
	146361	Basket strainer made of CNS 18/10, without soldered screw fitting, clear drain without plug
	137282	Basket strainer made of CNS 18/10, without soldered screw fitting, drain with 1½" stopper valve with ring

1½" eccentric drain set

Synthetic

	Item No.	Description
	137195	1½" eccentric drain set with Bowden cable and pull knob, chrome-plated, without overflow

1½" tube overflow with rubber taper



CNS 18/10

Item No.	Description
369961	with rubber taper, basket strainer made of CNS 18/10, without soldered screw fitting for basin depth of 150 mm, water level 130 mm
369962	with rubber taper, basket strainer made of CNS 18/10, without soldered screw fitting for basin depth of 200 mm, water level 180 mm
369963	with rubber taper, basket strainer made of CNS 18/10, without soldered screw fitting for basin depth of 250 mm, water level 200 mm
369964	for TOP drain with rubber taper, basket strainer made of CNS 18/10, without soldered screw fitting for basin depth of 300 mm, water level 250 mm

Accessories for stainless-steel basins

1 1/2" tube overflow with brass taper



CNS 18/10

Item No.	Description
340583	heavy design, with brass taper and basket strainer for basin depth of 150 mm, water level 130 mm
340584	heavy design, with brass taper and basket strainer for basin depth of 200 mm, water level 180 mm
340585	heavy design, with brass taper and basket strainer for basin depth of 250 mm, water level 200 mm
369965	heavy design, with brass taper and basket strainer for basin depth of 300 mm, water level 250 mm

Odour trap

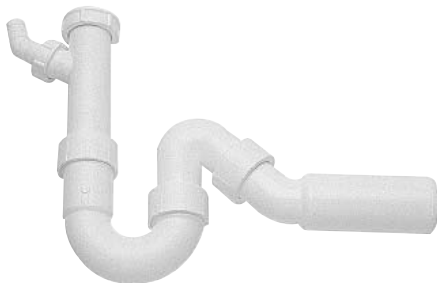

Synthetic

Item No.	Description
137267	Siphon, 1 1/2" synthetic pipe odour trap with adjustable drain, 50 mm dia. outlet
369971	Siphon, 2" synthetic pipe odour trap with adjustable drain, 50 mm dia. outlet

Accessories for stainless-steel basins

Drain connection

Synthetic

	Item No.	Description
	369969	1½" synthetic drain connection For double basin units

Cover ring

Synthetic

Item No.	Description
137832	Synthetic cover ring, white, NW 50, for use with 137267

Cover plate for drain trap

Item No.	Description
602154	2-piece with hole for odour trap for cut-out in cabinet rear wall

Mineral material table tops

Corian table top

with standard edge, 40 mm

Corian

Item No.	Depth mm	Description
MC0046	up to 500	Price group 1*, per running metre
MC0047	up to 600	Price group 1*, per running metre
MC0048	up to 700	Price group 1*, per running metre
MC0049	up to 800	Price group 1*, per running metre

* Colours for price group 1:

- Beach Glass
- Bisque
- Bone
- Butter Cream
- Cameo White
- Peach
- Pearl Grey
- Seagrass
- Vanilla

Manufacturer's specifications as at October 2008

Other price groups on request

Accessories for mineral material table tops

Corner for Corian table top

Item No.	Description
MC0069	Angled down
MC0070	Rounded off

Upward bevelling for Corian table top

Item No.	Depth mm	Height mm	Description
MC0067	12	40	with concave moulding, 40 mm high
MC0068	12	40	loose, 40 mm high

Fully rounded or slosh guard edge for Corian table top

Item No.
MC0066

Notch for Corian table top

Item No.
MC0072

Corner connection for Corian table top

Item No.
MC0071

Accessories for mineral material table tops

Cut-out for Corian table top

Item No.
MC0073

Basin for Corian table top incl. installation, 1½" tube overflow and odour trap, single colour

Corian

Item No.	Width mm	Depth mm	Height mm	Description
MC0080	276	318	167	Model 809 drain centred
MC0078	419	330	135	Model 810 oval
MC0077	680	430	175	Model FS-68 infant bath tub, single colour
MC0076	400	340	200	Model 859
MC0079	584	449	202	Model 871 drain centred
MC0075	444	494	220	Model 805
MC0074	339	399	208	Model 804

Fittings and mixer taps

160° S single-lever mixer tap

CNS 18/10

	Item No.	Description
	137462	Standard fitting with 160° swiveling faucet and pull-out hose shower, ceramic disc technology for drain quantities and maximum temperature limitation, 225 mm projection 35 mm dia. hole, 80 mm dia. countersunk area KWC, model K10T1.33000A02

BLANCOELIPSO single-lever mixer tap

CNS 18/10

	Item No.	Description
	511331	130° S vertical fitting with arm lever, 1/2" Single-lever mixer tap, with 90° swivelling cast drain, 200 mm projection, 35 mm dia. hole for tap required, with ceramic seal, flexible connection hoses with length of 450 mm and 3/8" nut for especially easy, secure mounting, patented stram controller/cascade for considerably reduced calcification, stabilising plate for increasing stability of mixer tap, Noise class 1 DIN DVGW tested

Vertical fitting for VE water level column



Laboratory vertical column for demineralised water

Item No.	Height mm	Description
542998	200	with corner valve, actuating handle coloured in accordance with DIN 12920 (E DIN EN 13792), fitting EPS-coated, grey (RAL 7001), chemically nickel-plated inside, screw hose fitting flat-sealing with hose nozzle (10/13 mm diameter) and stream controller in accordance with DIN 12898, Perbunan sealing disc and washer with counter-nut. G 3/4 B connection thread, 100 mm long. Maximum pressure at rest 10 bar. Maximum operating temperature 70° C.

Fittings and mixer taps

½" two-hole mixer tap

CNS 18/10

	Item No.	Height mm	Description
	137380		Wall fitting Spray wash arm for wall battery
	137379	1060	Vertical fitting with swivelling faucet, can be switched over to shower fitting, with automatically closing valve KWC, model K24.42.64.000C71, shower head projection 400 mm, tube riser wall distance 60 mm, table height up to UK shower head 270 mm, total height 1060 mm, hole spacing 153 mm, 22 mm dia. hole

Extension for wall mounting by an additional 60 mm for two-hole mixer tap

Item No.

127579

1½" cleaning gun

	Item No.	Description
	145310	with 8 shoulders ¾ and 1.5 m metal hose

Accessories for fittings and mixer taps

Compressed-air elbow connector for cleaning gun

Item No.
600060

Table ring for cleaning gun

Item No.	Description
145311	without hose taper 35 mm dia. hole

Shut-off valve

Item No.	Description
530090	3/4" shut-off valve 28 mm dia. hole

Accessories for table tops - general

Splash guard of vertical Plexiglas

with cut-out for vertical shelf or without cut-out, each incl. 3 x open bracket and 1 x closed bracket for front, size up to max. W = 665 mm, H = 490 mm

Item No.

543037

Support wall

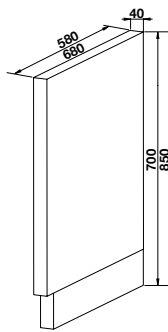

Powder-coated

Item No.	Depth mm	Description
53951001	580	for working height of 740 mm
53951003	580	for working height of 890 mm
53961002	680	for working height of 740 mm
53951004	680	for working height of 890 mm

CNS 18/10

Item No.	Depth mm	Description
53951005	580	for working height of 740 mm
53951007	580	for working height of 890 mm
53951006	680	for working height of 740 mm
53951008	680	for working height of 890 mm

Accessories for table tops - general

Support foot

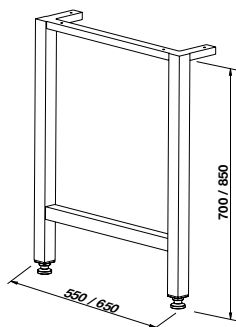

CNS 18/10

Item No.	Depth mm	Description
54983601	550	for working height of 740 mm, made of 40 mm tube
54983603	550	for working height of 890 mm, made of 40 mm tube
54983602	650	for working height of 740 mm, made of 40 mm tube
54983604	650	for working height of 890 mm, made of 40 mm tube

Mounting angle

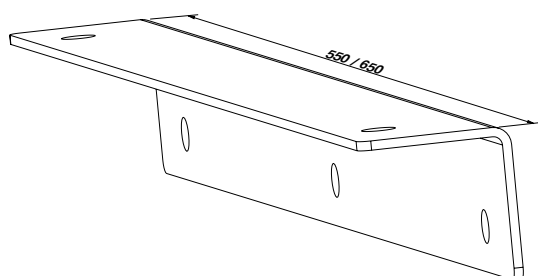

CNS 18/10

Item No.	Depth mm
531284	550
531285	650

Accessories for table tops - general

Bracket

Model KO

Bracket in stainless-steel tube

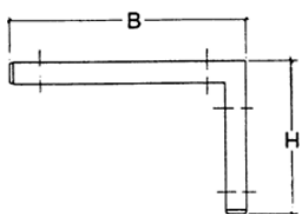

CNS 18/10

Item No.	Width mm	Description
54298001	475	in 25 mm tube
54298004	475	in 40 mm tube
54298002	575	in 25 mm tube
54298005	575	in 40 mm tube
54298003	675	in 25 mm tube
54298006	675	in 40 mm tube

Base cabinet DIN standard

Base cabinet, open

Model MOB
Shelf optional

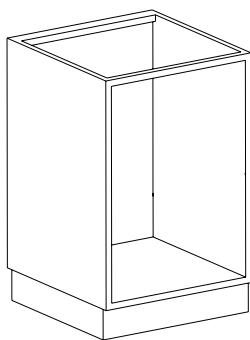

Powder-coated

CNS 18/10

Item No.	Width mm	Depth mm	Height mm	Item No.
53764001	450	557	700	54764001
53764002	600	557	700	54764002
53764003	900	557	700	54764003
53764004	1200	557	700	54764004
53764005	450	557	850	54764005
53764006	600	557	850	54764006
53764007	900	557	850	54764007
53764008	1200	557	850	54764008

Base cabinet with hinged door

Model MFB1
1 hinged door, left or right-hand hinging
1 handle element

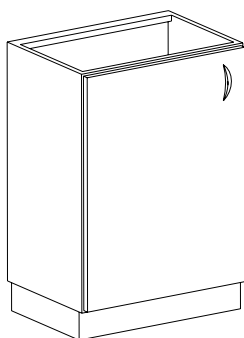

Powder-coated

CNS 18/10

Item No.	Width mm	Depth mm	Height mm	Item No.
53764101	450	580	700	54764101
53764105	600	580	700	54764105
53764109	450	580	850	54764109
53764113	600	580	850	54764113

Base cabinet DIN standard

Base cabinet with hinged door

Model MFB2

2 hinged doors
2 handle elements

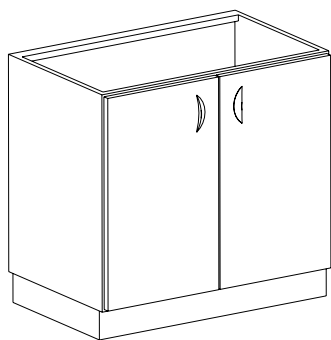

Powder-coated

CNS 18/10

Item No.	Width mm	Depth mm	Height mm	Item No.
53764201	900	580	700	54764201
53764203	1200	580	700	54764203
53764205	900	580	850	54764205
53764207	1200	580	850	54764207

Base cabinet with door and screen

Model MFBB1

1 hinged door, left or right-hand hinging
1 handle element
1 basin screen, 150 mm high

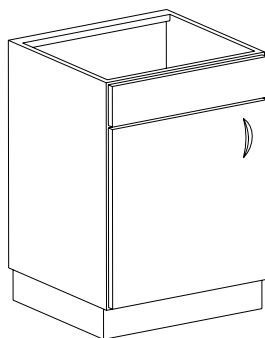

Powder-coated

CNS 18/10

Item No.	Width mm	Depth mm	Height mm	Item No.
53764301	450	580	850	54764301
53764305	600	580	850	54764305

Base cabinet DIN standard

Base cabinet with doors and screen

Model MFBB2

2 hinged doors

2 handle elements

1 basin screen, 150 mm high

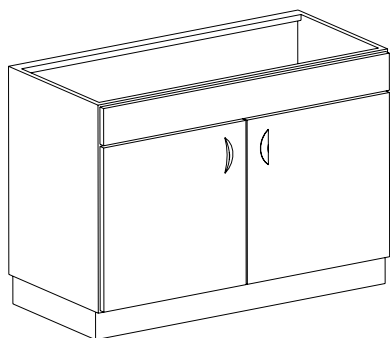

Powder-coated

CNS 18/10

Item No.	Width mm	Depth mm	Height mm	Item No.
53764401	900	580	850	54764401
53764403	1200	580	850	54764403

Base cabinet with door and drawer

Model MFBS1

1 hinged door, left or right-hand hinging

2 handle elements

1 drawer, 150 mm high

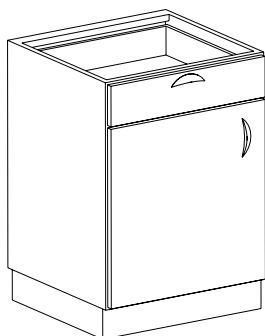

Powder-coated

CNS 18/10

Item No.	Width mm	Depth mm	Height mm	Item No.
53764501	450	580	700	54764501
53764505	600	580	700	54764505
53764509	450	580	850	54764509
53764513	600	580	850	54764513

Base cabinet DIN standard

Base cabinet with door and drawer

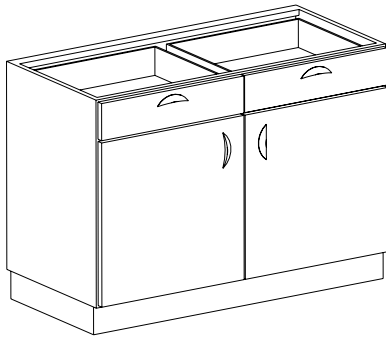

Model MFBS2

- 2 hinged doors
- 4 handle elements
- 2 drawers, 150 mm high

Powder-coated

CNS 18/10

Item No.	Width mm	Depth mm	Height mm	Item No.
53764601	900	580	700	54764601
53764603	1200	580	700	54764603
53764605	900	580	850	54764605
53764607	1200	580	850	54764607

Base cabinet with tilt drawer

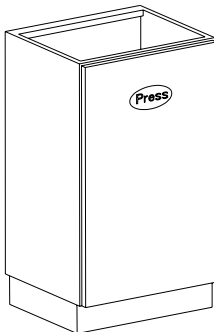

Model MKB

- 1 tilt drawer with pneumatic door brake, inside of door with fold-up hanging bars and shelf for synthetic garbage bags (60 ltr.)

Powder-coated

CNS 18/10

Item No.	Width mm	Depth mm	Height mm	Item No.
53764701	450	580	850	54764701
53764702	600	580	850	54764702

Base cabinet DIN standard

Base cabinet with extension

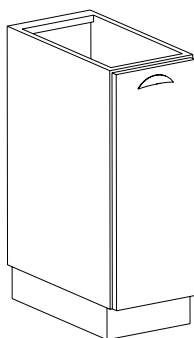

Model MLTA

1 extension with 1 CNS collection container
1 handle element

Powder-coated

Item No.	Width mm	Depth mm	Height mm	Description
53764801	300	580	850	Dimensions of CNS collection container: 195 x 425 x 550 mm or: 195 x 425 x 450 mm
53764802	450	580	850	Dimensions of CNS collection container: 345 x 425 x 550 mm or: 345 x 425 x 450 mm

CNS 18/10

Item No.	Width mm	Depth mm	Height mm	Description
54764801	300	580	850	Dimensions of CNS collection container: 195 x 425 x 550 mm or: 195 x 425 x 450 mm
54764802	450	580	850	Dimensions of CNS collection container: 345 x 425 x 550 mm or: 345 x 425 x 450 mm

Base cabinet DIN standard

Base cabinet with waste separation system

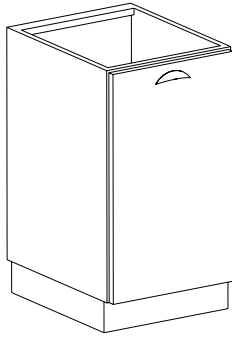

Model MLTAS

- 1 extension, manual extension
- 1 handle element
- integrated waste separation system
- BLANCOSELECT MED
- with 3 buckets (1 x 18.5 ltr.; 2 x 16 ltr.)

Powder-coated

CNS 18/10

Item No.	Width mm	Depth mm	Height mm	Item No.
53763301	600	580	850	54763301

Base cabinet with waste separation system



Model MLTASK

- 1 extension with knee actuation
- 1 basin screen

Powder-coated

Item No.	Width mm	Depth mm	Height mm	Description
54200302	450	580	850	integrated BLANCOSELECT MED waste separation system with 2 buckets (2 x 18.0 ltr.)
54200303	450	580	850	integrated BLANCOSELECT MED waste separation system with 3 buckets (1 x 18.0 ltr.; 2 x 8 ltr.)
54200301	600	580	850	integrated BLANCOSELECT MED waste separation system with 3 buckets (1 x 18.5 ltr.; 2 x 16 ltr.)

CNS 18/10

Item No.	Width mm	Depth mm	Height mm	Description
54200402	450	580	850	integrated BLANCOSELECT MED waste separation system with 2 buckets (2 x 18.0 ltr.)
54200403	450	580	850	integrated BLANCOSELECT MED waste separation system with 3 buckets (1 x 18.0 ltr.; 2 x 8 ltr.)
54200401	600	580	850	integrated BLANCOSELECT MED waste separation system with 3 buckets (1 x 18.5 ltr.; 2 x 16 ltr.)

Base cabinet DIN standard

Base cabinet with waste separation system and basin screen

Model MLTASB

- 1 manual extension
- 1 basin screen
- 1 handle element

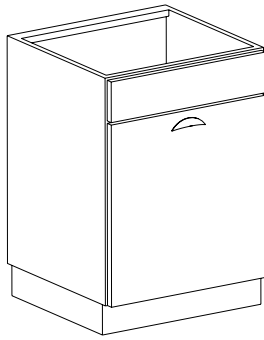

Powder-coated

Item No.	Width mm	Depth mm	Height mm	Description
53790202	450	580	850	integrated BLANCOSELECT MED waste separation system with 3 buckets (1 x 18.5 ltr.; 2 x 8 ltr.)
53790201	600	580	850	integrated BLANCOSELECT MED waste separation system with 3 buckets (1 x 18.5 ltr.; 2 x 16 ltr.)

CNS 18/10

Item No.	Width mm	Depth mm	Height mm	Description
54243302	450	580	850	integrated BLANCOSELECT MED waste separation system with 3 buckets (1 x 18.5 ltr.; 2 x 8 ltr.)
54243301	600	580	850	integrated BLANCOSELECT MED waste separation system with 3 buckets (1 x 18.5 ltr.; 2 x 16 ltr.)

Base cabinet with drawers

Model MLT/3

- 3 drawers, 200 mm high each
- 3 handle elements

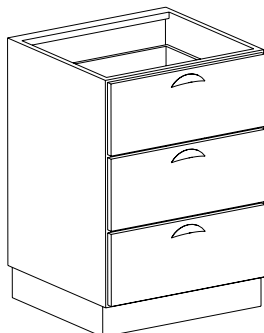

Powder-coated

CNS 18/10

Item No.	Width mm	Depth mm	Height mm	Item No.
53765001	450	580	700	54765001
53765003	600	580	700	54765003

Base cabinet DIN standard

Base cabinet with drawers

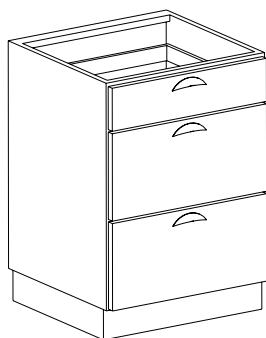

Model MLT/3

2 drawers, 300 mm high each
1 drawer, 150 mm high
3 handle elements

Powder-coated

CNS 18/10

Item No.	Width mm	Depth mm	Height mm	Item No.
53765005	450	580	850	54765005
53765007	600	580	850	54765007

Base cabinet with drawers

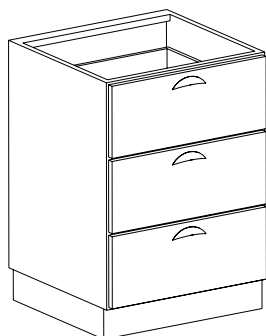

Model MLT/3

3 drawers, 250 mm high each
3 handle elements

Powder-coated

CNS 18/10

Item No.	Width mm	Depth mm	Height mm	Item No.
53765009	450	580	850	54765009
53765011	600	580	850	54765011

Base cabinet DIN standard

Base cabinet with drawers

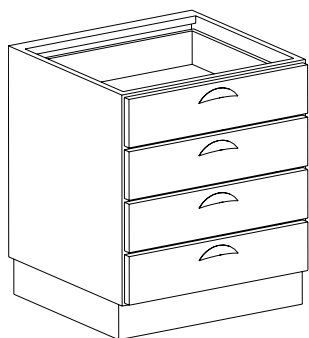

Model MLT/4

4 drawers, 150 mm high each
4 handle elements

Powder-coated

CNS 18/10

Item No.	Width mm	Depth mm	Height mm	Item No.
53765013	450	580	700	54765013
53765015	600	580	700	54765015

Base cabinet with drawers

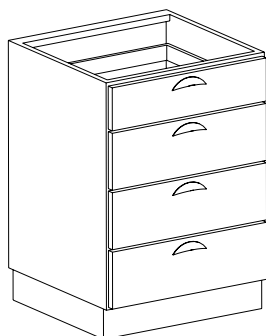

Model MLT/4

3 drawers, 200 mm high each
1 drawer, 150 mm high
4 handle elements

Powder-coated

CNS 18/10

Item No.	Width mm	Depth mm	Height mm	Item No.
53765017	450	580	850	54765017
53765019	600	580	850	54765019

Base cabinet DIN standard

Base cabinet with drawers

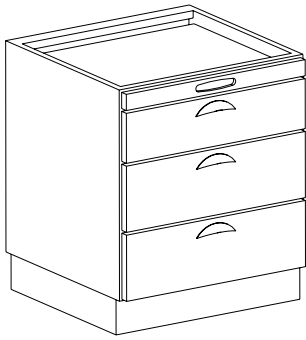

Model MLT/4

with pull-out worktop
2 drawers, 200 mm high each
1 drawer, 150 mm high
1 pull-out worktop, 50 mm high
4 handle elements

Powder-coated

CNS 18/10

Item No.	Width mm	Depth mm	Height mm	Item No.
53765021	450	580	700	54765021
53765023	600	580	700	54765023

Base cabinet with drawers

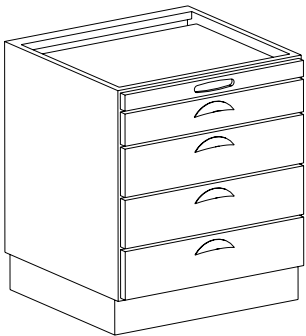

Model MLT/5

with pull-out worktop
3 drawers, 150 mm high each
1 drawer, 100 mm high
1 pull-out worktop, 50 mm high
5 handle elements

Powder-coated

CNS 18/10

Item No.	Width mm	Depth mm	Height mm	Item No.
53765025	450	580	700	54765025
53765027	600	580	700	54765027

Base cabinet DIN standard

Base cabinet with drawers

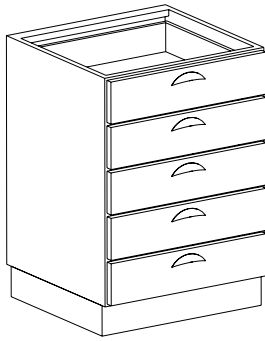

Model MLT/5

5 drawers, 150 mm high each
5 handle elements

Powder-coated

CNS 18/10

Item No.	Width mm	Depth mm	Height mm	Item No.
53765029	450	580	850	54765029
53765031	600	580	850	54765031
53765033	900	580	850	54765033
53765035	1200	580	850	54765035

Base cabinet with drawers and door

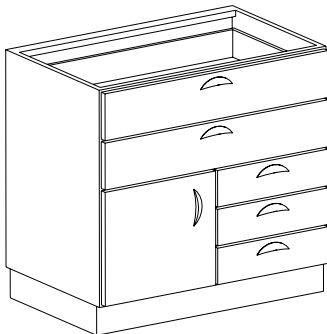

Model MLTF/5

1 hinged door, left-hand hinging
3 drawers, 150 mm high, 450 mm wide each
2 drawers, 150 mm high, 900 mm wide each
6 handle elements

Powder-coated

CNS 18/10

Item No.	Width mm	Depth mm	Height mm	Item No.
53765101	900	580	850	54765101

Base cabinet DIN standard

Base cabinet with drawers

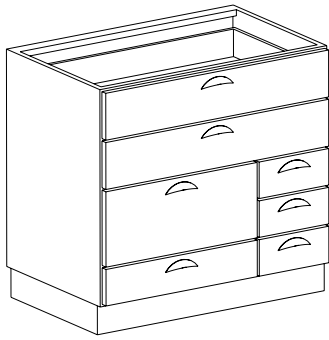

Model MLT/7

3 drawers, 150 mm high, 300 mm wide each
 1 drawer, 150 mm high, 600 mm wide
 1 drawer, 300 mm high, 600 mm wide
 2 drawers, 150 mm high, 900 mm wide each
 7 handle elements

Powder-coated

CNS 18/10

Item No.	Width mm	Depth mm	Height mm	Item No.
53765201	900	580	850	54765201

Base cabinet with sliding doors

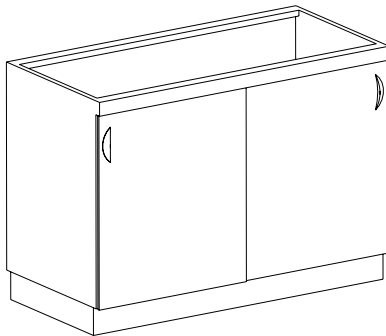

Model MSB

2 sliding doors
 35 mm screen in front colour
 2 handle elements

Powder-coated

CNS 18/10

Item No.	Width mm	Depth mm	Height mm	Item No.
53765301	900	580	850	54765301
53765303	1200	580	850	54765303
53765305	1500	580	850	54765305

Base cabinet DIN standard

Base cabinet with sliding doors and basin screen

Model MSBB

2 sliding doors

2 handle elements

1 basin screen, 150 mm high in front colour

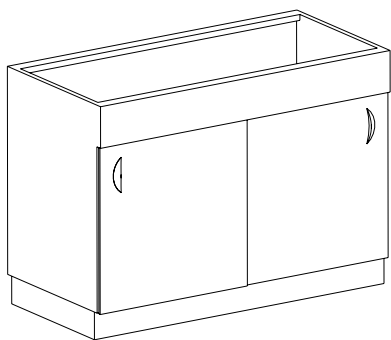

Powder-coated

CNS 18/10

Item No.	Width mm	Depth mm	Height mm	Item No.
53765401	900	580	850	54765401
53765403	1200	580	850	54765403
53765405	1500	580	850	54765405

Corner base cabinet

Model MEBE

1 hinged door, right-hand hinging

1 fixed shelf

1 handle element

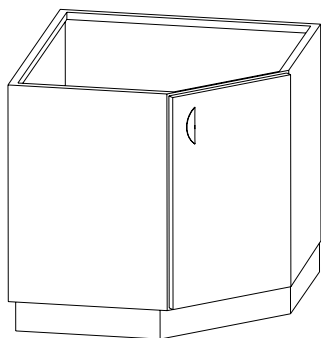

Powder-coated

CNS 18/10

Item No.	Width mm	Depth mm	Height mm	Item No.
53765501	900	580	850	54765501

Base cabinet DIN standard

Corner base cabinet

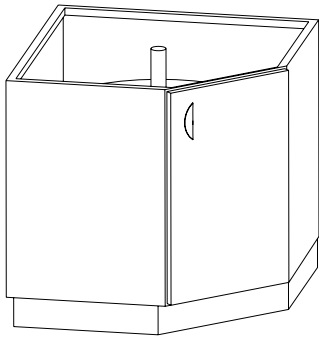

Model MEBD

- 1 hinged door, right-hand hinging
- 2 rotating shelves
- 1 handle element

Powder-coated

CNS 18/10

Item No.	Width mm	Depth mm	Height mm	Item No.
53765601	900	580	850	54765601

Corner base cabinet

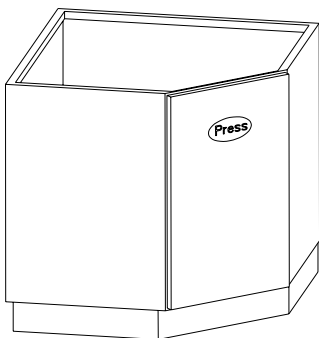

Model MEBK

- 1 tilt drawer with pneumatic door brake,
- inner side of door with
- fold-up hanging bars and shelf for synthetic garbage bags

Powder-coated

CNS 18/10

Item No.	Width mm	Depth mm	Height mm	Item No.
53762501	900	580	850	54762501

Base cabinet DIN standard

Base cabinet with hinged door for DIN module

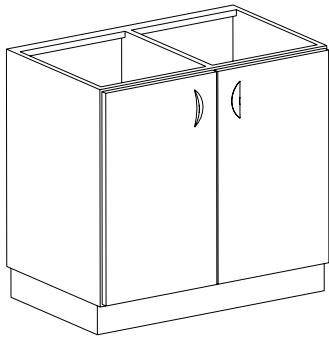

Model EMFB2

2 hinged doors

1 centre partition wall

2 handle elements

without equipment

for mounting DIN modules, size 535 x 500 mm

Powder-coated

CNS 18/10

Item No.	Width mm	Depth mm	Height mm	Item No.
53770501	1200	580	700	54770501
53770503	1200	580	850	54770503

Base cabinet for refrigeration unit

Base cabinet for drug refrigerator

Model MFBK

Price without refrigeration unit

1 outer door, left or right-hand hinging

lockable with lever lock

for installing a drug refrigerator, Kirsch, Med. 85, 80 ltr.,

or with Froster Med 70, connection 220 V - 135 W

1 handle element

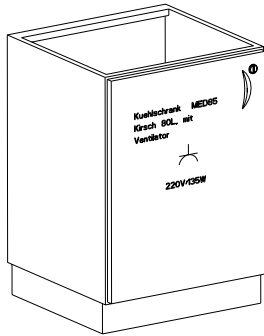

Powder-coated

CNS 18/10

Item No.	Width mm	Depth mm	Height mm	Item No.
53765701	600	580	850	54765701

Base refrigerator

Model MUK

Left or right-hand hinging

Base refrigerator, approx. 150 ltr., adjustable from

+2° to + 10° C, with automatic defroster and -18°C

freezer compartment

Liebherr KUw 1544, with decorative screen

and ventilation plate in front colour, connection

230 V - 110 W

(other makes on request)

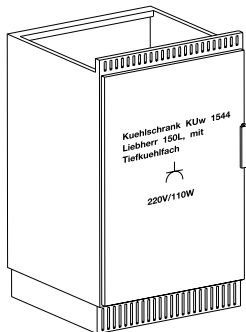

Powder-coated

CNS 18/10

Item No.	Width mm	Depth mm	Height mm	Item No.
53765801	600	580	850	54765801

Base cabinet with heating device

Heating cabinet - base cabinet

Model MFBW1

Not suitable for storing infusions

1 lockable hinged door, left or right-hand hinging

2 cabinet shelves, CNS 18/10, perforated

1 handle element

Output 1000 W

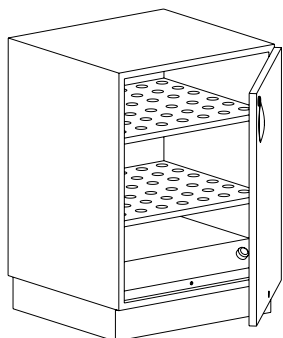

Powder-coated

CNS 18/10

Item No.	Width mm	Depth mm	Height mm	Item No.
53765901	600	580	850	54765901

Heating cabinet - base cabinet

Model MFBW2

Not suitable for storing infusions

2 lockable hinged doors

2 perforated cabinet shelves made of CNS 18/10

2 handle elements

Output 2000 W

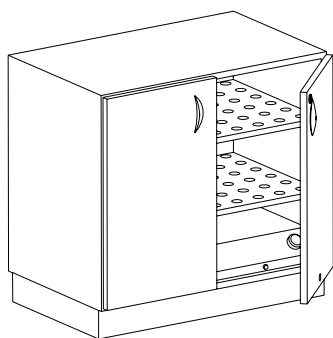

Powder-coated

CNS 18/10

Item No.	Width mm	Depth mm	Height mm	Item No.
54208401	900	580	700	54208601
54208403	1200	580	700	54208603
54208405	900	580	850	54208605
54208407	1200	580	850	54208607

Base cabinet for drain

Drain base cabinet

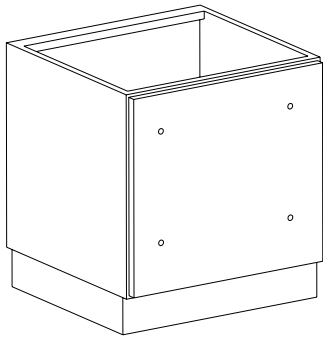

Model MBB

for hospital drain

1 revision plate, removable

Powder-coated

CNS 18/10

Item No.	Width mm	Depth mm	Height mm	Item No.
53766201	600	580	600	54766201

Drain base cabinet

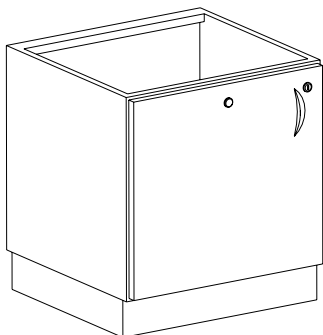

Model MFAB1

for hospital drain,

pressure increase system can be integrated

1 hinged door, left or right-hand hinging,
lockable

1 handle element

Powder-coated

CNS 18/10

Item No.	Width mm	Depth mm	Height mm	Item No.
53766101	600	580	600	54766101

Base cabinet for ultrasound unit

Base cabinet for installing an ultrasound unit

Model MFBBUS2

2 hinged doors

2 handle elements

1 switch panel, 150 mm high in CNS 18/10

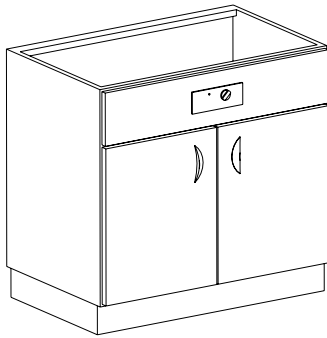

Powder-coated

CNS 18/10

Item No.	Width mm	Depth mm	Height mm	Item No.
53766301	900	580	850	54766301

Bandelin ZE 1058 ultrasound unit complete

Model SONOREX ZE 1058 ST 15

Control unit with time switch for 1 - 15 minutes and continuous operation, complete with Bandelin SONOREX ZE1058 ultrasonic cleaning unit



Item No.	Width mm	Depth mm	Height mm	Description
542988	600	400	200	consisting of GT1000M HF generator, max. output 2 x 1200 W/period, frequency 35 KHz, with 16 vibration elements including TE1058 vibration well of CNS 18/10, drain on either left or right, dim. 600 x 400 x 200 mm suitable for DIN-STU and ISO standard sieve dishes, including drain set, basket carrier, insert basket and lid

Base cabinet for ultrasound unit

Bandelin ZE 1058 DT ultrasound unit



with ST 30 DT digital control unit with temperature control in vibration well and temperature sensor, complete with Bandelin SONOREX ZE1058 ultrasonic cleaning unit

Item No.	Width mm	Depth mm	Height mm	Description
MC0157	600	400	200	consisting of GT1000M HF generator, max. output 2 x 1200 W/period, frequency 35 KHz, with 16 vibration elements including TE1058 vibration well of CNS 18/10, drain on either left or right, dim. 600 x 400 x 200 mm suitable for DIN-STU and ISO standard sieve dishes, including drain set, basket carrier, insert basket and lid

Bandelin control unit for ultrasound unit ST 30 DT



Item No.	Description
MC0106	added price for STE 30 DT digital control unit of SONOREX Super ZE 1058 ultrasound unit (ST 15 control unit is eliminated)

Base cabinet for ultrasound unit

SONOMIC MC 1000 ultrasound unit, complete

Model SONOMIC MC 1000

Bandelin ultrasound unit for hollow bodies for disinfection and cleaning of max. 12 washable MIC instruments with K 1000 MC basket and D 1000 MC lid, table-top unit



CNS

Item No.	Width mm	Depth mm	Height mm	Thickness mm	Description
542989	860	490	415	2	Vibration well, inside: 650 x 400 x 210/230* mm *angled well bottom) (LxWxD), working filling capacity: 35 ltr., drain: fitting with rotary handle operation, vibration system: 12 PZT large-area vibration system, ultrasound frequency: 40 kHz, peak ultrasound output: 2400 W, HF output: 600 W, maintenance heating 400 W, current consumption: 2.9 A, weight with basket and lid: 40 kg Stainless steel 1.4571, titanium-stabilised, 2 mm thick

Medisafe ultrasound unit, complete

Model MED 1134 SI Digital

complete with accessories, ultrasound unit for 6 to 12 hollow instruments

Item No.	Width mm	Depth mm	Height mm	Description
542990	656	301	156	Cut-out dimensions: 656 x 301 mm Basin dimensions: 651 x 294 x 156 mm

Infant care unit and accessories

Infant care unit

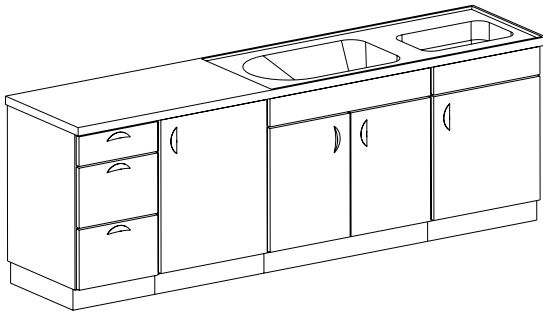

Model MSE 25/9

CNS table top with 1 welded-in hand-washing basin (500 x 300 x 150 mm) and infant tub (720 x 420 x 300 mm), with all-round profile edge in wet area.

1 base cabinet, 450 mm wide, with 2 drawers, 300 mm high each and 1 drawer, 150 mm high

1 base cabinet, 600 mm wide with 1 hinged door, right-hand hinging, inside 1 wood/synthetic cabinet shelf

1 base cabinet, 900 mm wide with 2 hinged doors and basin screen

1 base cabinet, 600 mm wide with 1 hinged door, right-hand hinging and basin screen

7 handle elements

Powder-coated

Item No.	Width mm	Depth mm	Height mm
MC0137	2570	600	890

Height-adjustable nappy changing table unit



CNS pipe frame with electrohydraulic height adjustment by means of lowerable control panel with cleaning-friendly film keyboard. With integrated base cabinets and infant bath tub, Corian table top

Consisting of:

1 pipe frame - 150 mm height-adjustable

2 MLT base cabinets

2 MLTABK base cabinets

6 handle elements

Powder-coated

Item No.	Depth mm	Height mm
MC0134	680	930 - 1080

Infant care unit and accessories

Nappy changing pad, white cover

Synthetic leather cover, 800 x 580 x 40 mm

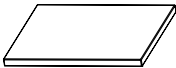
	Item No.	Width mm	Depth mm	Height mm
	241192	800	580	40

Synthetic drain valve

Item No.	Description
146361	Basket strainer made of CNS 18/10, without soldered screw fitting (clear drain without plug)

1½" eccentric drain set

Synthetic

	Item No.	Description
	137195	1½" eccentric drain set with Bowden cable and pull knob, chrome-plated, without overflow

Gynecology cabinet

Gynaecology base cabinet

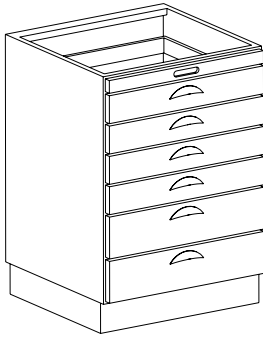

Model MLTW

2 drawers, 150 mm high each
4 drawers, 100 mm high each with pre-heating device
1 switch panel, 50 mm high
6 handle elements

Powder-coated

Item No.	Width mm	Depth mm	Height mm
53763501	450	580	850
53763503	600	580	850

Gynaecology base cabinet

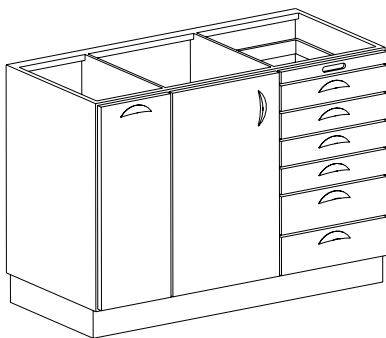

Model MLTBW/GYN

Left: 1 pull-out door with bracket for large plastic garbage bag
Centre: 1 hinged door with left-hand hinging with container for specula moisturizing, waste, swab forceps and swab containers
Right: 2 drawers, 150 mm high each
4 drawers, 100 mm high each with pre-heating device
1 switch panel, 50 mm high
8 handle elements

Powder-coated

Item No.	Width mm	Depth mm	Height mm
53763401	1200	580	850

Gynecology cabinet

Gynecology unit

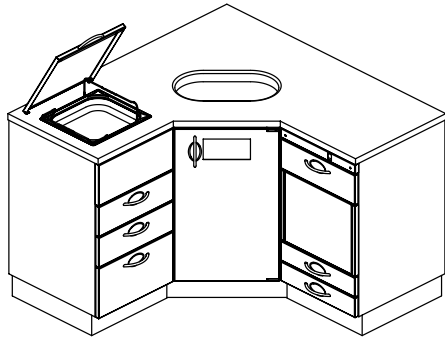

Powder-coated

Item No.	Description
MC0131	<p>consisting of: MLTB drawer cabinet, MEBF corner cabinet with tilt waste door, MLTKWGYN tilt door cabinet and hinged lid for GN 2/3, without cover</p> <p>MEBF corner cabinet with tilt waste door, with synthetic garbage can attached to door (12 litres)</p> <p>MLTB cabinet with GN 2/3 container with tilt cover, 2 drawers, 150 mm high, 1 drawer, 200 mm high</p> <p>Heating cabinet with heatable drawer, 150 mm high (warming unit), door can be lowered into body, 2 drawers, 100 mm high</p> <p>7 handle elements</p>

Plaster bench system and accessories

Plaster bench system

Model MGA 27/9

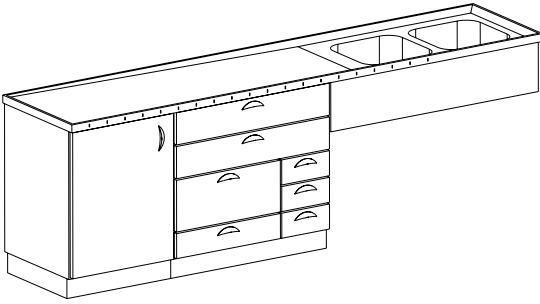

CNS 18/10

Item No.	Width mm	Depth mm	Height mm	Description
MC0135	2720	600	890	Table top made of CNS 18/10 with 2 welded-in basins, 400 x 400 x 200 mm, with all-round profile edge and incline down to basins. Measuring marks stamped in on front turned down edge. 1 base cabinet, 600 mm wide with hinged door, left or right-hand hinging, with 1 cabinet shelf made of CNS 18/10 1 base cabinet, 900 mm wide, with 6 drawers, 150 mm high each and 1 drawer, 300 mm high in basin area, 1 screen, 1200 mm long and 255 mm high 8 handle elements

Measuring marks for plaster bench

Item No.

MC0035

Plaster bench system and accessories

1½" tube overflow

CNS 18/10

Item No.	Description
137055	with rubber taper, basket strainer made of CNS 18/10, without soldered screw fitting for basin depth of 200 mm, water level 180 mm

Drain connection

Synthetic

	Item No.	Description
	137157	1½" synthetic drain connection For double basin units

Plaster sedimentation basin, mobile, model EWL 90

Item No.	Width mm	Height mm	Description
543022	560	585	Model EWL 90 90 litre capacity, without roll-in device

Plaster bench system and accessories

Synthetic plaster catch basin

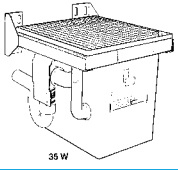
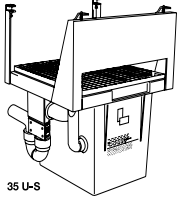
	Item No.	Description
 35 W	146292	Model 35 W for wall mounting, can be pulled out for disposal
 35 U-S	146317	Model 35 T for cabinet mounting, can be pulled out for disposal

Basin screen

Powder-coated

Item No.	Height mm	Description
54800501	255	straight
54800601	255	L-shaped

High cabinet DIN standard

High cabinet - open

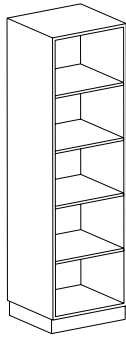

Model MOBH
Shelves optional

Powder-coated

CNS 18/10

Item No.	Width mm	Depth mm	Height mm	Item No.
53767201	450	557	2100	54767201
53767202	600	557	2100	54767202
53767203	900	557	2100	54767203
53767204	1200	557	2100	54767204

High cabinet with hinged door

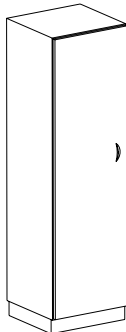

Model MFBH1
1 hinged door, left or right-hand hinging
1 handle element

Powder-coated

CNS 18/10

Item No.	Width mm	Depth mm	Height mm	Item No.
53767301	450	580	2100	54767301
53767305	600	580	2100	54767305

High cabinet DIN standard

High cabinet with hinged doors

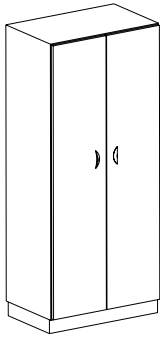

Model MFBH2

2 hinged doors

2 handle elements

Powder-coated

CNS 18/10

Item No.	Width mm	Depth mm	Height mm	Item No.
53767401	900	580	2100	54767401
53767403	1200	580	2100	54767403

High cabinet with glass door

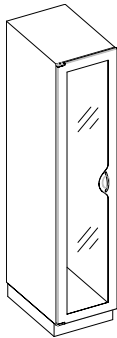

Model MGBH1

hinged door with glass insert, left or right-hand hinging

1 handle element

Powder-coated

CNS 18/10

Item No.	Width mm	Depth mm	Height mm	Item No.
53762601	450	580	2100	54762601
53762605	600	580	2100	54762605

High cabinet DIN standard

High cabinet with glass doors

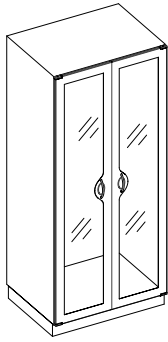

Model MGBH2

2 hinged doors with glass insert
2 handle elements

Powder-coated

CNS 18/10

Item No.	Width mm	Depth mm	Height mm	Item No.
53762701	900	580	2100	54762701
53762703	1200	580	2100	54762703

High drug cabinet



Model MFMH1

1 hinged door, left or right-hand hinging
1 handle element
8 drug containers on inside of door
(shelves shortened - in accordance with accessories)

Powder-coated

CNS 18/10

Item No.	Width mm	Depth mm	Height mm	Item No.
53767901	600	580	2100	54767901

High cabinet DIN standard

High drug cabinet

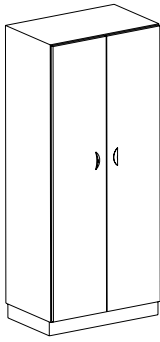

Model MFMH2

2 hinged doors

2 handle elements

16 drug containers on inside of door

(shelves shortened - in accordance with accessories)

Powder-coated

CNS 18/10

Item No.	Width mm	Depth mm	Height mm	Item No.
53768001	900	580	2100	54768001
53768003	1200	580	2100	54768003

High drawer cabinet



Model MLTFH1

1 hinged door, left or right-hand hinging

5 drawers, 250 mm high each

6 handle elements

Powder-coated

CNS 18/10

Item No.	Width mm	Depth mm	Height mm	Item No.
53768301	600	580	2100	54768301

High cabinet DIN standard

High drawer cabinet

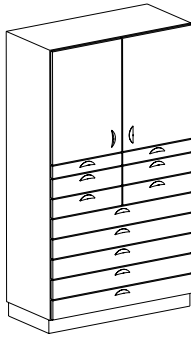

Model MLTFH2/11

2 hinged doors

2 drawers, 100 mm high, 600 mm wide each

4 drawers, 150 mm high, 600 mm wide each

5 drawers, 150 mm high, 1200 mm wide each

13 handle elements

Powder-coated

CNS 18/10

Item No.	Width mm	Depth mm	Height mm	Item No.
53790601	1200	580	2100	53790701

High drawer cabinet

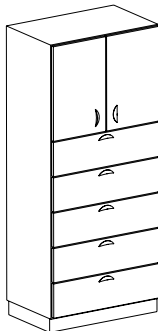

Model MLTFH2

2 hinged doors

5 drawers, 250 mm high each

7 handle elements

Powder-coated

CNS 18/10

Item No.	Width mm	Depth mm	Height mm	Item No.
53768401	900	580	2100	54768401

High cabinet DIN standard

High OT accessories cabinet

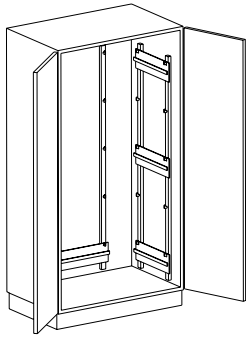

Model MFOPH2

2 hinged doors

2 handle elements

Brackets and slide rails at left and rear (for 900 mm width), at left, right and rear (for 1200 mm width) on inner walls for mounting OT table accessories

Powder-coated

CNS 18/10

Item No.	Width mm	Depth mm	Height mm	Item No.
53770001	900	580	2100	54770001
53770003	1200	580	2100	54770003

High cabinet with roller shutter door

Model MRBH

with anodised aluminium roller door

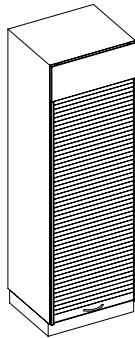

Powder-coated

Item No.	Width mm	Depth mm	Height mm
54296901	600	580	2100

High cabinet DIN standard

High cabinet with pull-out wall for instruments

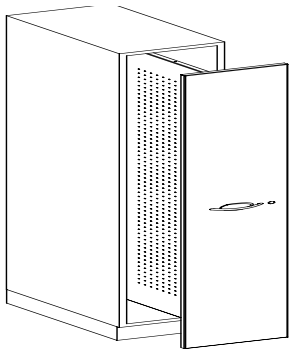

Model MFIZM

with 2 pull-out perforated system walls (made of powder-coated steel), with handle, for hooking in a maximum of 60 system hooks per wall, individually adjustable, without accessories,

max. total loading capacity: 130 kg

Powder-coated

Item No.	Width mm	Depth mm	Height mm
543025	600	580	2100

System hooks for high cabinet with pull-out wall for instruments

perforated wall hooks for perforated system wall, length 100 mm, hook-in bridge for 30 mm hole spacing, wire diameter 4 mm

CNS

Item No.
601790

High cabinet DIN standard

High cabinet with hinged doors for DIN module

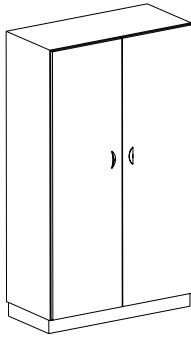

Model EMFBH2

- 2 hinged doors
- 1 centre partition wall
- 2 handle elements
- without equipment

Powder-coated

Item No.	Width mm	Depth mm	Height mm	Description
53771101	1200	580	2100	for mounting DIN modules, size 535 x 500 mm

CNS 18/10

Item No.	Width mm	Depth mm	Height mm	Description
54771101	1200	580	2100	for mounting DIN modules, size 535 x 500 mm

High cabinet with glass doors for DIN module

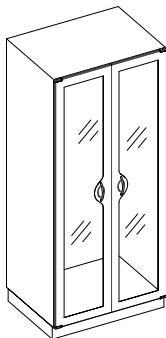

Model EMGBH2

- 2 hinged doors with glass insert
- 1 centre partition wall
- 2 handle elements
- without equipment

Powder-coated

Item No.	Width mm	Depth mm	Height mm	Description
53790401	1200	580	2100	for mounting DIN modules, size 535 x 500 mm

CNS 18/10

Item No.	Width mm	Depth mm	Height mm	Description
53790501	1200	580	2100	for mounting DIN modules, size 535 x 500 mm

Implant cabinet

Base cabinet - implant cabinet

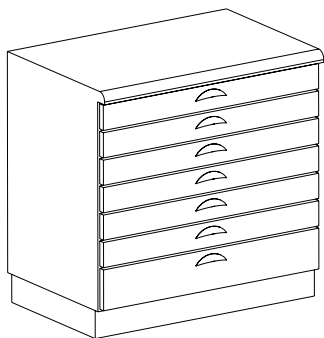

Model MLTI

6 drawers with variable compartment dividers made of CNS for implants and accessories, 100 mm high each
 1 drawer with variable compartment dividers made of CNS 18/10 for implants and accessories, 150 mm high
 all drawers with full extension; 7 handle elements
 Base cabinet with variable compartment dividers made of CNS 18/10
 Max. load per drawer. 30 kg if distributed evenly

Powder-coated

CNS 18/10

Item No.	Width mm	Depth mm	Height mm	Item No.
53789101	900	680	890	53789301

High cabinet - implant cabinet

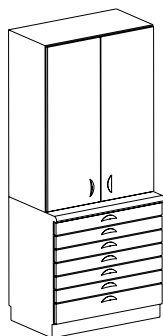

Model MLTFBHI

Implant cabinet

Top:

1 top-mounted cabinet with 2 hinged doors with synthetic small-parts housings for implants and accessories (top-mounted cabinet depth: 480 mm)

Bottom:

6 drawers with variable compartment dividers made of CNS 18/10 for implants and accessories, 100 mm high each, 1 drawer with variable metal compartment dividers for implants and accessories, 150 mm high; with cover made of CNS 18/10

9 handle elements

Max. load per drawer. 30 kg if distributed evenly

Powder-coated

CNS 18/10

Item No.	Width mm	Depth mm	Height mm	Item No.
54200101	900	680	2100	54200201

Implant cabinet

Accessories for implant cabinet

Item No.	Width mm	Depth mm	Height mm	Description
340296				L116H41 compartment divider, CNS 18/10
340310				H42 lateral divider assy., CNS 18/10
340295				L560H41 compartment divider, CNS 18/10
340297				L116H68 compartment divider, CNS 18/10
340311				H69 lateral divider assy., CNS 18/10
146748				Partition walls for BK-20, yellow,
146750				Partition walls for BK-30, yellow,
542994				Labels for implant cabinet - BK 20 small parts magazine for MRK 93
542995				Labels for implant cabinet - BK 30 small parts magazine for MRK 186
146749	93	400	83	BK-30 small parts magazine, yellow
146747	185	400	83	BK-20 small parts magazine, yellow

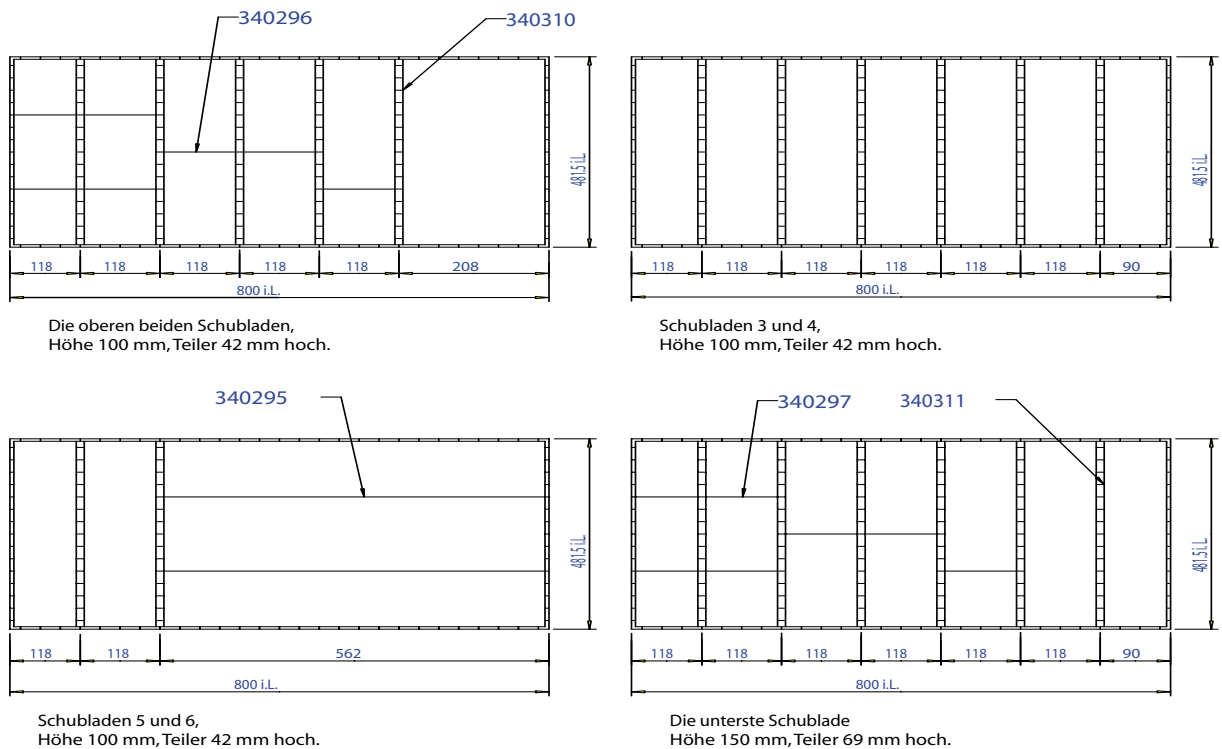

Endoscopy cabinet

High endoscopy cabinet



Model MFEZH1 1VT

- 1 hinged door, left or right-hand hinging
- 1 handle element
- 1 vertical partition wall, can be pulled out toward front, with special bracket for 4 endoscopes

Powder-coated

Item No.	Width mm	Depth mm	Height mm
53768501	300	580	2100
53768505	450	580	2100
53768509	600	580	2100

High endoscopy cabinet

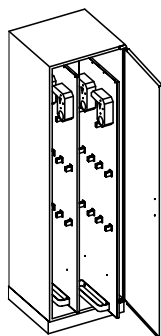

Model MFEZH1 2VT

- 1 hinged door, left or right-hand hinging
- 1 handle element
- 2 vertical partition walls, can be pulled out toward front, with special bracket for 8 endoscopes

Powder-coated

Item No.	Width mm	Depth mm	Height mm
53768601	600	580	2100

Endoscopy cabinet

High endoscopy cabinet

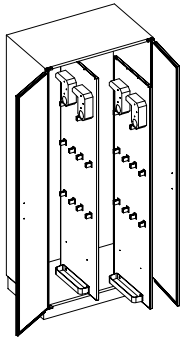

Model MFEZH2 2VT

2 hinged doors
2 handle elements
2 vertical partition walls, can be pulled out toward front,
with special bracket
for 8 endoscopes

Powder-coated

Item No.	Width mm	Depth mm	Height mm
53768701	900	580	2100

High endoscopy cabinet

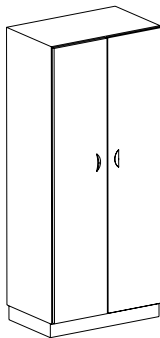

Model MFEZH2 3VT

2 hinged doors
2 handle elements
3 vertical partition walls, can be pulled out toward front,
with special bracket for 12 endoscopes

Powder-coated

Item No.	Width mm	Depth mm	Height mm
53768801	900	580	2100

Endoscopy cabinet

High endoscopy cabinet

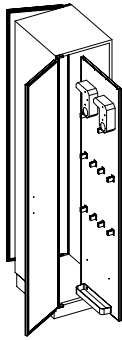

Model MFEZ DRH 1VT

2 hinged doors as pass-through cabinet
2 handle elements
1 vertical partition wall, can be pulled out on both sides,
with special bracket
for 4 endoscopes

Powder-coated

Item No.	Width mm	Depth mm	Height mm
543032	450	600	2100

High endoscopy cabinet

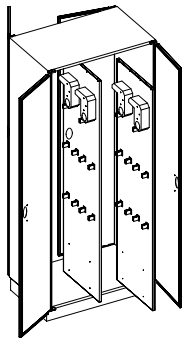

Model MFEZ DRH 2VT

4 hinged doors as pass-through cabinet
4 handle elements
2 vertical partition walls, can be pulled out on both sides,
with special bracket
for 8 endoscopes

Powder-coated

Item No.	Width mm	Depth mm	Height mm
543033	600	600	2100

Endoscopy cabinet

High endoscopy cabinet

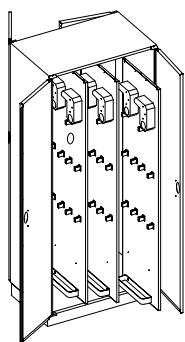

Model MFEZ DRH 3VT

4 hinged doors as pass-through cabinet
4 handle elements
3 vertical partition walls, can be pulled out on both sides, with special bracket for 12 endoscopes

Powder-coated

Item No.	Width mm	Depth mm	Height mm
543034	900	600	2100

High endoscopy cabinet with carousel

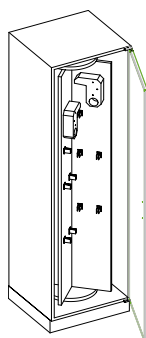

Model MFEKH1

with carousel with bracket for 8 endoscopes
1 hinged door, 1 handle element

Powder-coated

Item No.	Width mm	Depth mm	Height mm
543035	600	580	2100

Endoscopy cabinet

High endoscopy cabinet with carousel

Model MFEKDRH1

with carousel with bracket for 8 endoscopes
2 hinged doors as pass-through cabinet,
2 handle elements

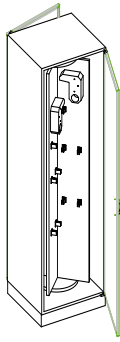

Powder-coated

Item No.	Width mm	Depth mm	Height mm
543036	600	600	2100

Catheter cabinet

High catheter cabinet

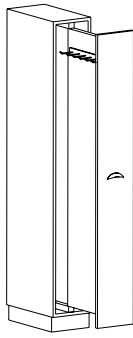

Model MFHZH1 1VT

1 vertical extension with 12 hooks,
1 handle element

Optional:

U-shaped CNS bar for holding catheter ends

Powder-coated

Item No.	Width mm	Depth mm	Height mm
54238201	300	580	2100

High catheter cabinet

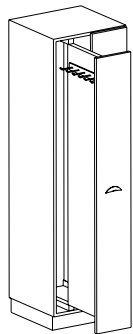

Model MFHZH1 2VT

2 vertical extensions with 12 hooks each,
2 handle elements

Optional:

U-shaped CNS bar for holding catheter ends

Powder-coated

Item No.	Width mm	Depth mm	Height mm
54238001	600	580	2100

Catheter cabinet

High catheter cabinet

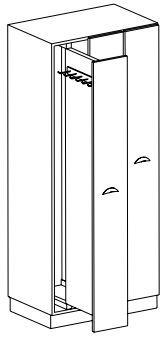

Model MFHZH1 3VT

3 vertical extensions with 12 hooks each,

3 handle elements

Optional:

U-shaped CNS bar for holding catheter ends

Powder-coated

Item No.	Width mm	Depth mm	Height mm
54238101	900	580	2100

Bar for bracing catheters

U-shaped bar for vertical extensions

CNS

Item No.
604513

Drug cabinet

High drug cabinet

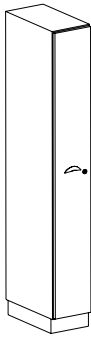

Model MLTAH/1

1 vertical drug extension, 300 mm wide, with central lock, 10 adjustable compartment inserts and 40 lateral dividers made of Plexiglas
1 handle element

Powder-coated

CNS 18/10

Item No.	Width mm	Depth mm	Height mm	Item No.
53768901	300	580	2100	54768901

High drug cabinet



Model MLTAH/2

2 vertical drug extensions, 300 mm wide each, with central lock, 10 adjustable compartment inserts and 40 lateral dividers each made of Plexiglas
2 handle elements

Powder-coated

CNS 18/10

Item No.	Width mm	Depth mm	Height mm	Item No.
53769001	600	580	2100	54769001

Drug cabinet

High drug cabinet

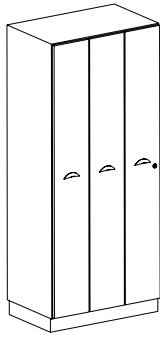

Model MLTAH/3

3 vertical drug extensions, 300 mm wide each,
with central lock,
10 adjustable compartment inserts and 40 lateral
dividers each
made of Plexiglas
3 handle elements

Powder-coated

CNS 18/10

Item No.	Width mm	Depth mm	Height mm	Item No.
53769101	900	580	2100	54769101

Instrument cabinet

Instrument cabinet

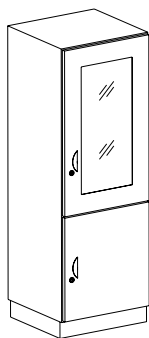

Model MPFG1

Top:

1 hinged door with glass insert,
left or right-hand hinging

Bottom:

1 hinged door, left or right-hand hinging

lockable

4 glass cabinet shelves

2 handle elements

Powder-coated

Item No.	Width mm	Depth mm	Height mm
53789801	600	480	1750

Instrument cabinet

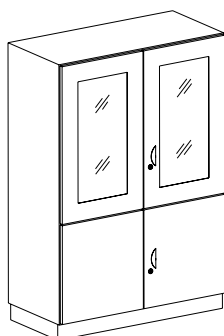

Model MPFG2

2 doors with glass insert and stop bar at top,
with 4 glass cabinet shelves

2 doors with stop bar at bottom,
lockable

2 handle elements

Powder-coated

Item No.	Width mm	Depth mm	Height mm
53789901	1200	480	1750

High cabinet for refrigeration unit

High cabinet for drug refrigerator

Model MLTKH

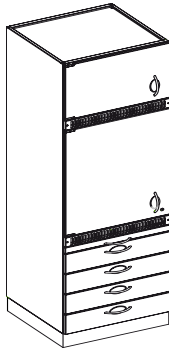

for drug refrigerator installed in centre
Med. 85, Kirsch, 80 ltr., with outer door, flush at front,
lockable, connection 220 V - 135 W
1 hinged door at top, left or right-hand hinging
Bottom:
1 pull-out worktop, 50 mm high
4 drawers, 150 mm high each
7 handle elements

Powder-coated

CNS 18/10

Item No.	Width mm	Depth mm	Height mm	Item No.
53769201	600	580	2100	54769201

High cabinet for drug refrigerator

Model MLTKOH

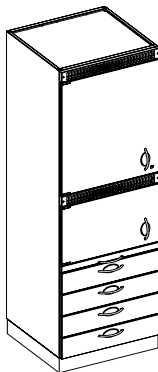

for drug refrigerator installed at top
Med. 85, Kirsch, 80 ltr., with outer door, flush at front,
lockable, connection 220 V - 135 W
1 hinged door centred, left or right-hand hinging
Bottom:
1 pull-out worktop, 50 mm high
4 drawers, 150 mm high
7 handle elements

Powder-coated

CNS 18/10

Item No.	Width mm	Depth mm	Height mm	Item No.
53769301	600	580	2100	54769301

High cabinet for refrigeration unit

High cabinet for drug refrigerator

Model MFBKH

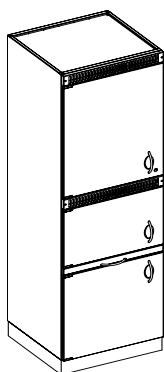

for drug refrigerator installed in centre
Med. 85, Kirsch, 80 ltr., with outer door, flush at front,
lockable, connection 220 V - 135 W
1 hinged door each at top and bottom,
left or right-hand hinging
1 pull-out worktop at bottom, 50 mm high
4 handle elements

Powder-coated

CNS 18/10

Item No.	Width mm	Depth mm	Height mm	Item No.
53769401	600	580	2100	54769401

High cabinet for drug refrigerator

Model MFBKOH

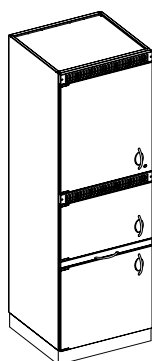

for drug refrigerator installed at top
Med. 85, Kirsch, 80 ltr., with outer door, flush at front,
lockable, connection 220 V - 135 W
1 hinged door each in centre and at bottom,
left or right-hand hinging
1 pull-out worktop, 50 mm high between
4 handle elements

Powder-coated

CNS 18/10

Item No.	Width mm	Depth mm	Height mm	Item No.
53769501	600	580	2100	54769501

High cabinet for refrigeration unit

High cabinet for refrigerator

Model MLTHKH

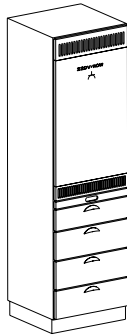

for refrigerator installed at top
Liebherr EK 1514, with freezer compartment, 127 ltr.,
connection 230 V - 110 W, energy efficiency class A+
Bottom:

- 1 pull-out worktop, 50 mm high
- 1 drawer, 150 mm high
- 3 drawers, 200 mm high each
- 5 handle elements

Powder-coated

CNS 18/10

Item No.	Width mm	Depth mm	Height mm	Item No.
53769601	600	580	2100	54769601

High cabinet for refrigerator

Model MFBHKH

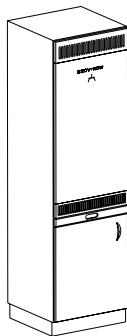

for refrigerator installed at top
Liebherr EK 1514, with freezer compartment, 127 ltr.,
connection 230 V - 110 W, energy efficiency class A+,
1 pull-out worktop, 50 mm high
1 hinged door, left or right-hand hinging
2 handle elements

Powder-coated

CNS 18/10

Item No.	Width mm	Depth mm	Height mm	Item No.
53769701	600	580	2100	54769701

High cabinet for refrigeration unit

High cabinet for drug refrigerator

Model MFBKGBH

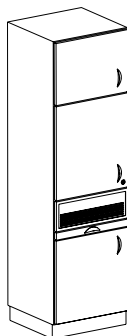

Centre: Compartment with outer door, lockable for refrigeration unit installation

Top: 1 hinged door, left or right-hand hinging

Bottom: 1 pull-out worktop, 50 mm high and 1 hinged door, left or right-hand hinging,

4 handle elements

Powder-coated

Item No.	Width mm	Depth mm	Height mm	Description
53762101	600	580	2100	for MED-100 drug refrigerator installed in centre
53762105	600	580	2100	for MED-95 Froster installed in centre
53762109	600	580	2100	for BL-100 stored blood refrigerator installed in centre

CNS 18/10

Item No.	Width mm	Depth mm	Height mm	Description
54762101	600	580	2100	for MED-100 drug refrigerator installed in centre
54762105	600	580	2100	for MED-95 Froster installed in centre
54762109	600	580	2100	for BL-100 stored blood refrigerator installed in centre

High cabinet for refrigeration unit

High cabinet for refrigeration units

Model MFBKGB2H



for installation of two Kirsch refrigerators (Med 100, MED 95 Froster or BL 100 stored blood refrigerator)

2 compartments with outer door,
lockable for refrigeration unit installation
2 handle elements

Powder-coated

Item No.	Width mm	Depth mm	Height mm
542029	600	580	2100

High cabinet for refrigeration unit

Model MLTKGBH

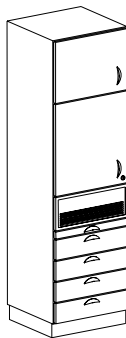

Centre: compartment with outer door, lockable
for refrigeration unit installation,
Top: 1 hinged door, left or right-hand hinging
Bottom:
1 pull-out worktop, 50 mm high
4 drawers, 150 mm high each
7 handle elements

Powder-coated

Item No.	Width mm	Depth mm	Height mm	Description
53762201	600	580	2100	for MED-100 drug refrigerator installed in centre
53762205	600	580	2100	for MED-95 Froster installed in centre
53762209	600	580	2100	for BL-100 stored blood refrigerator installed in centre

CNS 18/10

Item No.	Width mm	Depth mm	Height mm	Description
54762201	600	580	2100	for MED-100 drug refrigerator installed in centre
54762205	600	580	2100	for MED-95 Froster installed in centre
54762209	600	580	2100	for BL-100 stored blood refrigerator installed in centre

High cabinet for refrigeration unit

High cabinet for drug refrigerator

Model MFBKH1

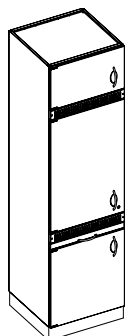

for drug refrigerator installed in centre
 Med. 125, Kirsch, 120 ltr., with outer door, flush at
 front, lockable, connection 220 V - 135 W
 1 hinged door each at top and bottom,
 left or right-hand hinging
 1 pull-out worktop at bottom, 50 mm high
 4 handle elements

Powder-coated

CNS 18/10

Item No.	Width mm	Depth mm	Height mm	Item No.
542935	600	580	2100	542937

High cabinet for drug refrigerator

Model MLTKH1

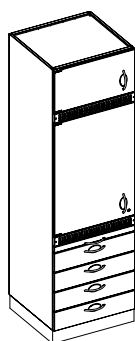

for Kirsch Med. 125 drug refrigerator installed
 in centre, 120 ltr., with outer door, flush at front,
 lockable, connection 220 V - 135 W
 Top:
 1 hinged door, left or right-hand hinging
 Bottom:
 1 pull-out worktop, 50 mm high
 4 drawers, 150 mm high each
 7 handle elements

Powder-coated

CNS 18/10

Item No.	Width mm	Depth mm	Height mm	Item No.
542936	600	580	2100	542938

High warming cabinet

High warming cabinet

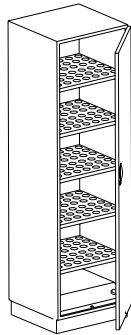

Model MFBWH1

Not suitable for storing infusions

1 lockable hinged door, left or right-hand hinging

5 perforated cabinet shelves made of CNS 18/10

1 handle element

Output 1000 W

Powder-coated

CNS 18/10

Item No.	Width mm	Depth mm	Height mm	Item No.
53770101	600	580	2100	54770101

High warming cabinet

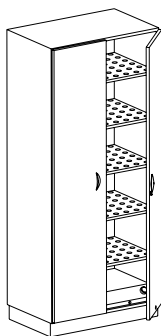

Model MFBWH2

Not suitable for storing infusions

2 lockable hinged doors

5 perforated cabinet shelves made of CNS 18/10

2 handle elements

Output 2000 W

Powder-coated

CNS 18/10

Item No.	Width mm	Depth mm	Height mm	Item No.
54208301	900	580	2100	54208501
54208303	1200	580	2100	54208503

High warming cabinet

High cabinet with warming device

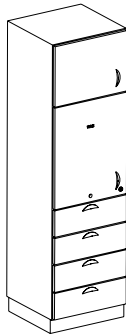

Model MLTWH1

Not suitable for storing infusions

Top: 1 hinged door, left or right-hand hinging

Centre: 1 warming compartment, output 1000 W,
2 cabinet shelves made of CNS 18/10, perforated,

lockable,

Left or right-hand hinging

Bottom: 4 drawers, 200 mm high each

6 handle elements

Powder-coated

CNS 18/10

Item No.	Width mm	Depth mm	Height mm	Item No.
53762301	600	580	2100	54762301

High cabinet with warming device

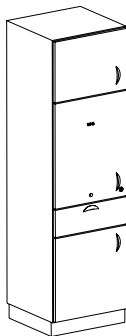

Model MFBSWMH1

Not suitable for storing infusions

1 hinged door each at top and bottom,
left or right-hand hinging

Centre: 1 warming compartment, lockable,
output 1000 W, 2 cabinet shelves made of CNS

18/10, perforated,

Left or right-hand hinging

Bottom: 1 drawer, 200 mm high

4 handle elements

Powder-coated

CNS 18/10

Item No.	Width mm	Depth mm	Height mm	Item No.
53762401	600	580	2100	54762401

Combination cabinet

High cabinet with warming compartment and built-in refrigeration unit

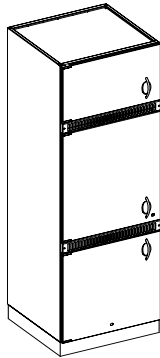

Model MFBWKGH

Not suitable for storing infusions

Top:

1 hinged door, left or right-hand hinging,
for refrigeration unit installed in centre, lockable

Bottom:

installed warming compartment, lockable,
with 2 cabinet shelves made of CNS 18/10,
perforated, output 1000 W

3 handle elements

Powder-coated

Item No.	Width mm	Depth mm	Height mm	Description
53762001	600	580	2100	for MED-85 drug refrigerator, lockable
53762005	600	580	2100	for MED-70 Froster, lockable,

CNS 18/10

Item No.	Width mm	Depth mm	Height mm	Description
54762001	600	580	2100	for MED-85 drug refrigerator, lockable,
54762005	600	580	2100	for MED-70 Froster, lockable,

Warming drawer

Warming drawer for infusions



with perforated bottom, switch panel and LED display for display of inside temperature.

Capacity: Drawer 450 mm wide: 12 x 1 l or 20 x 0.5 ltr. bottles; drawer 600 mm: 20 x 1 l or 32 x 0.5 ltr. bottles; drawer 660 mm wide: 24 x 1 ltr. or 36 x 0.5 ltr. bottles, temperature adjustable from +33 °C to +37 °C, set to + 37 °C at factory, overtemperature protection at 46 °C, self-limiting PTC heating element, connected load: 220 - 240 V AC, 50 - 60 Hz, 400 W, 1.7 A; frame height 233 mm, loading height: screen height minus 50 mm;
Class 2a medical product

Powder-coated

CNS 18/10

Item No.	Width mm	Depth mm	Height mm	Connection	Item No.
34678401	450 - 660	580 - 680	350 - 375	Connected load: 220 - 240 V AC, 50 - 60 Hz, 400 W, 1.7 A	34678402

Warming drawer for linens



with perforated bottom, switch panel and LED display for display of inside temperature.

Temperature adjustable from 40° C to 65 °C, overtemperature protection, self-limiting PTC heating element, mains connection: 220 - 240 V AC, 50 - 60 Hz, power consumption 400 W, 1.7 A
Frame height 233 mm;
Loading height: screen height minus 50 mm

Powder-coated

CNS 18/10

Item No.	Width mm	Depth mm	Height mm	Connection	Item No.
54306401	450 - 660	580 - 680	350 - 375	Connected load: 220 - 240 V AC, 50 - 60 Hz, 400 W, 1.7 A	54306402

Wall cabinet DIN standard

Wall cabinet - open

Model MHO
Shelves optional

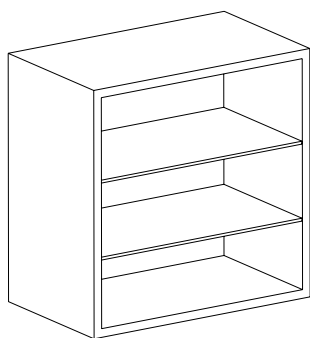

Powder-coated

CNS 18/10

Item No.	Width mm	Depth mm	Height mm	Item No.
53766401	450	277	600	54766401
53766402	600	277	600	54766402
53766403	900	277	600	54766403
53766404	1200	277	600	54766404
53766409	450	357	600	54766409
53766410	600	357	600	54766410
53766411	900	357	600	54766411
53766412	1200	357	600	54766412
53766405	450	277	750	54766405
53766406	600	277	750	54766406
53766407	900	277	750	54766407
53766408	1200	277	750	54766408
53766413	450	357	750	54766413
53766414	600	357	750	54766414
53766415	900	357	750	54766415
53766416	1200	357	750	54766416

Wall cabinet DIN standard

Wall cabinet with hinged door

Model MHF1

1 hinged door, left or right-hand hinging
1 handle element

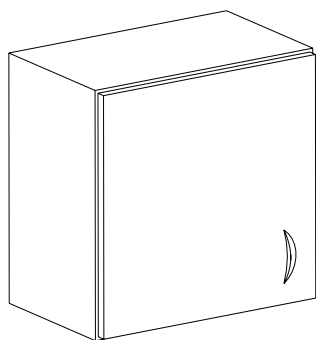

Powder-coated

CNS 18/10

Item No.	Width mm	Depth mm	Height mm	Item No.
53766501	450	300	600	54766501
53766505	600	300	600	54766505
53766517	450	380	600	54766517
53766521	600	380	600	54766521
53766509	450	300	750	54766509
53766513	600	300	750	54766513
53766525	450	380	750	54766525
53766529	600	380	750	54766529

Wall cabinet with hinged doors

Model MHF2

2 hinged doors,
2 handle elements

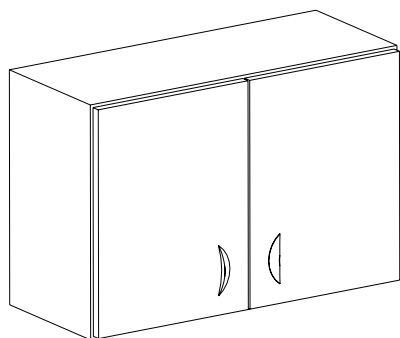

Powder-coated

CNS 18/10

Item No.	Width mm	Depth mm	Height mm	Item No.
53766601	900	300	600	54766601
53766603	1200	300	600	54766603
53766609	900	380	600	54766609
53766611	1200	380	600	54766611
53766605	900	300	750	54766605
53766607	1200	300	750	54766607
53766613	900	380	750	54766613
53766615	1200	380	750	54766615

Wall cabinet DIN standard

Wall cabinet with sliding doors

Model MHS
2 sliding doors,
2 handle elements

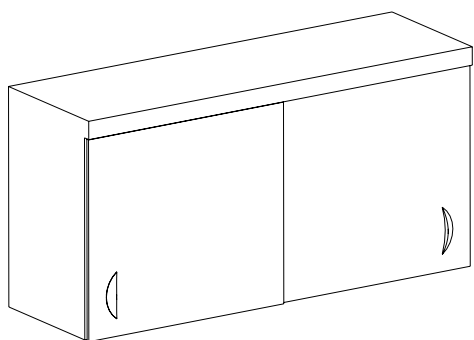

Powder-coated

CNS 18/10

Item No.	Width mm	Depth mm	Height mm	Item No.
53766701	900	300	600	54766701
53766703	1200	300	600	54766703
53766709	900	380	600	54766709
53766711	1200	380	600	54766711
53766705	900	300	750	54766705
53766707	1200	300	750	54766707
53766713	900	380	750	54766713
53766715	1200	380	750	54766715

Wall cabinet with roller shutter door

Model MHR
with anodised aluminium roller door

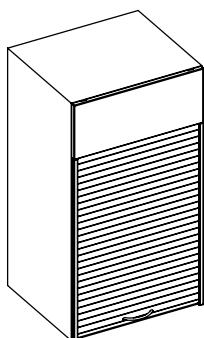

Powder-coated

Item No.	Width mm	Depth mm	Height mm
54301701	600	380	600
54301702	900	380	600

Wall cabinet DIN standard

Wall cabinet with glass doors

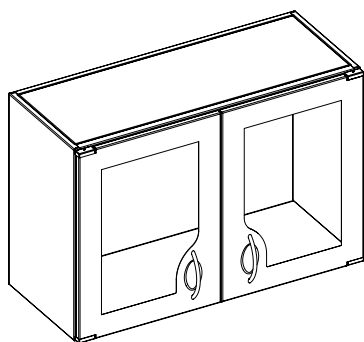

Model MHG

with 2 hinged doors with glass insert, 2 handle elements, glass shelf optional

Powder-coated

CNS 18/10

Item No.	Width mm	Depth mm	Height mm	Item No.
54281501	900	300	600	54287201
54281502	1200	300	600	54287202
54281505	900	380	600	54287205
54281506	1200	380	600	54287206
54281503	900	300	750	54287203
54281504	1200	300	750	54287204
54281507	900	380	750	54287207
54281508	1200	380	750	54287208

Wall cabinet with folding door

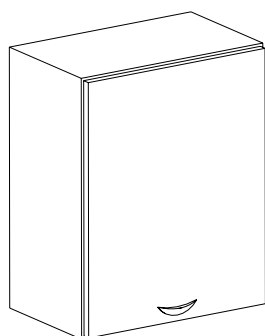

Model MHK

1 folding door,
1 handle element

Powder-coated

CNS 18/10

Item No.	Width mm	Depth mm	Height mm	Item No.
53766801	450	380	600	54766801
53766803	600	380	600	54766803
53766805	900	380	600	54766805
53766807	450	380	750	54766807
53766809	600	380	750	54766809
53766811	900	380	750	54766811

Wall cabinet DIN standard

Wall cabinet with hinged doors for DIN module

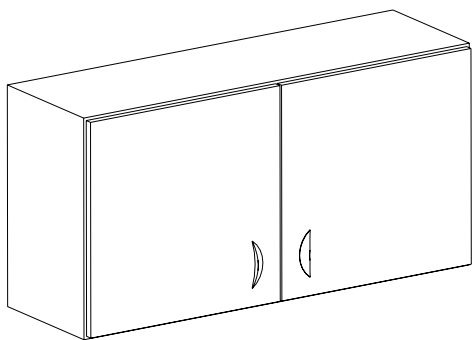

Model EMHF2

2 hinged doors
1 centre partition wall
2 handle elements
without equipment
for mounting DIN modules
of the size 538 x 250 mm

Powder-coated

Item No.	Width mm	Depth mm	Height mm	Description
53770801	1200	380	600	DIN module

CNS 18/10

Item No.	Width mm	Depth mm	Height mm	Description
54770801	1200	380	600	DIN module

Top-mounted cabinet DIN standard

Top-mounted cabinet with hinged door

Model MFBA1

- 1 hinged door, left or right-hand hinging
- 1 handle element

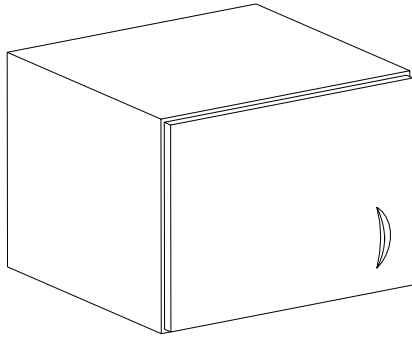

Powder-coated

CNS 18/10

Item No.	Width mm	Depth mm	Height mm	Item No.
53767001	450	580	450	54767001
53767013	600	580	450	54767013
53767005	450	580	600	54767005
53767017	600	580	600	54767017
53767009	450	580	750	54767009
53767021	600	580	750	54767021

Top-mounted cabinet with hinged doors

Model MFBA2

- 2 hinged doors
- 2 handle elements

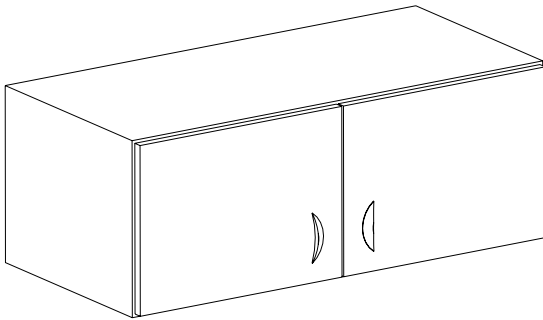

Powder-coated

CNS 18/10

Item No.	Width mm	Depth mm	Height mm	Item No.
53767101	900	580	450	54767101
53767107	1200	580	450	54767107
53767103	900	580	600	54767103
53767109	1200	580	600	54767109
53767105	900	580	750	54767105
53767111	1200	580	750	54767111

Base cabinet ISO module

Base cabinet with hinged door

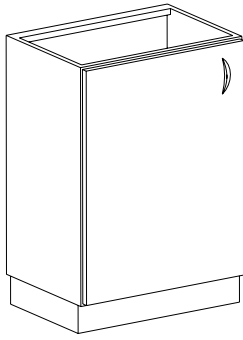

Model SMFB1

1 hinged door, left or right-hand hinging
1 handle element
for mounting ISO modules
of the size 600 x 400 mm,
without equipment

Powder-coated

CNS 18/10

Item No.	Width mm	Depth mm	Height mm	Item No.
53771209	660	480	700	54771209
53771201	460	680	700	54771201
53771213	660	480	850	54771213
53771205	460	680	850	54771205

Base cabinet with hinged doors

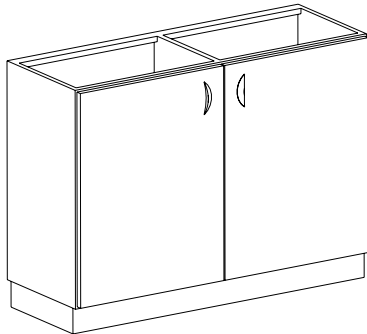

Model SMFB2

2 hinged doors,
2 handle elements,
1 centre partition wall, for equipment of ISO modules
of the size 600 x 400 mm,
without equipment

Powder-coated

CNS 18/10

Item No.	Width mm	Depth mm	Height mm	Item No.
53771305	1320	480	700	54771305
53771301	920	680	700	54771301
53771307	1320	480	850	54771307
53771303	920	680	850	54771303

Base cabinet ISO module

Base cabinet with drawers

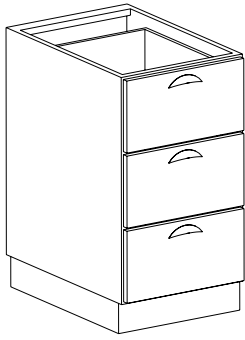

Model SMLT

3 drawer fronts, 250 mm high each,
Hanging frame with full extension
3 handle elements
for mounting ISO modules
of the size 600 x 400 mm

Powder-coated

CNS 18/10

Item No.	Width mm	Depth mm	Height mm	Item No.
53789703	660	480	850	53790803
53789701	460	680	850	53790801

Base cabinet with drawers

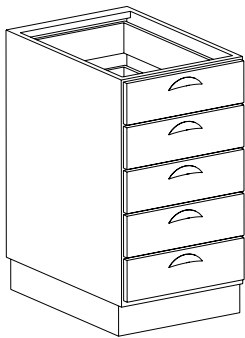

Model SMLT

5 drawer fronts, 150 mm high each,
Hanging frame with full extension
5 handle elements
for mounting ISO modules
of the size 600 x 400 mm

Powder-coated

CNS 18/10

Item No.	Width mm	Depth mm	Height mm	Item No.
53789707	660	480	850	53790807
53789705	460	680	850	53790805

Base cabinet ISO module

Base cabinet with tilt drawer

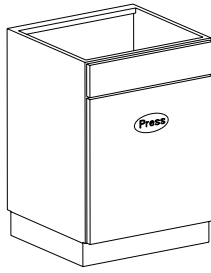

Model SMKB

1 tilt drawer with pneumatic door brake, inside of door with fold-up hanging bars and shelf for synthetic garbage bags (60 ltr.)

Powder-coated

CNS 18/10

Item No.	Width mm	Depth mm	Height mm	Item No.
53764902	660	480	850	54764902
53764901	460	680	850	54764901

High cabinet ISO module

High cabinet with hinged door



Model SMFBH1

1 hinged door, left or right-hand hinging
1 handle element
without equipment
for mounting ISO modules
of the size 600 x 400 mm

Powder-coated

CNS 18/10

Item No.	Width mm	Depth mm	Height mm	Item No.
53771805	660	480	2100	54771805
53771801	460	680	2100	54771801

High cabinet with hinged doors



Model SMFBH2

2 hinged doors
2 handle elements
1 centre partition wall
without equipment
for mounting ISO modules
of the size 600 x 400 mm

Powder-coated

CNS 18/10

Item No.	Width mm	Depth mm	Height mm	Item No.
53771903	1320	480	2100	54771903
53771901	920	680	2100	54771901

High cabinet ISO module

High cabinet for drug refrigerator

Model MFBKH

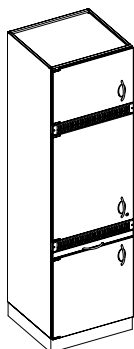

for Kirsch Med. 85 drug refrigerator installed in centre,
80 ltr., with outer door, flush at front, lockable
Connection 220 V - 135 W
1 hinged door each at top and bottom,
left or right-hand hinging
1 pull-out worktop at bottom, 50 mm high
4 handle elements
without equipment

Powder-coated

CNS 18/10

Item No.	Width mm	Depth mm	Height mm	Item No.
53769405	660	580	2100	54769405

High cabinet with glass door

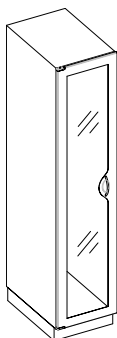

Model SMGBH1

1 hinged door with glass insert,
left or right-hand hinging
1 handle element
without equipment
for mounting ISO modules
of the size 600 x 400 mm

Powder-coated

CNS 18/10

Item No.	Width mm	Depth mm	Height mm	Item No.
53763005	660	480	2100	54763005
53763001	460	680	2100	54763001

High cabinet ISO module

High cabinet with glass doors

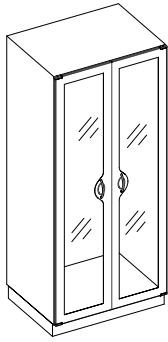

Model SMGBH2

2 hinged doors with glass insert
2 handle elements
1 centre partition wall
without equipment
for mounting ISO modules
of the size 600 x 400 mm

Powder-coated

CNS 18/10

Item No.	Width mm	Depth mm	Height mm	Item No.
53763103	1320	480	2100	54763103
53763101	920	680	2100	54763101

High cabinet ISO with roller shutter door

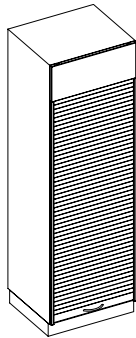

Model SMRBH

with anodised aluminium roller door
without equipment
for equipping with ISO modules
of the size 600 x 400 mm

Powder-coated

Item No.	Width mm	Depth mm	Height mm	Description
54296904	660	480	2100	without partition wall
54296905	1320	480	2100	with partition wall
54296902	460	680	2100	without partition wall
54296903	920	680	2100	with partition wall

Wall cabinet ISO module

Wall cabinet with hinged door

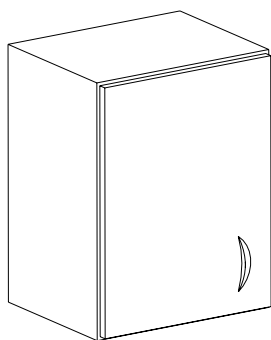

Model SMHF1

1 hinged door, left or right-hand hinging
1 handle element
without equipment
for mounting ISO modules
of the size 300 x 400 mm

Powder-coated

CNS 18/10

Item No.	Width mm	Depth mm	Height mm	Item No.
53771401	460	380	600	54771401

Wall cabinet with hinged doors

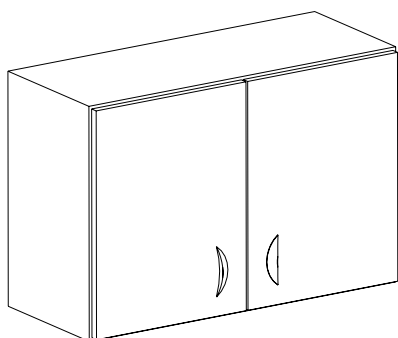

Model SMHF2

2 hinged doors
2 handle elements
1 centre partition wall
without equipment
for mounting ISO modules
of the size 300 x 400 mm

Powder-coated

CNS 18/10

Item No.	Width mm	Depth mm	Height mm	Item No.
53771501	920	380	600	54771501

Wall cabinet ISO module

Wall cabinet ISO with roller shutter door

Model SMHR

with anodised aluminium roller door
for equipping with ISO modules
of the size 300 x 400 mm
without equipment

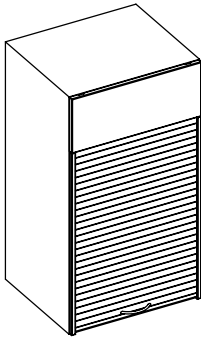

Powder-coated

Item No.	Width mm	Depth mm	Height mm	Description
54301703	460	380	600	without partition wall
54301704	920	380	600	with partition wall

Top-mounted cabinet ISO module

Top-mounted cabinet with hinged door

Model SMFBA1

1 hinged door, left or right-hand hinging
1 handle element
without equipment
for mounting ISO modules
of the size 600 x 400 mm

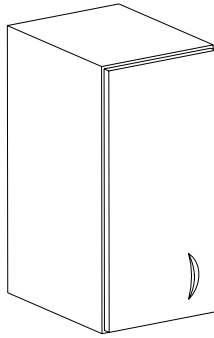

Powder-coated

CNS 18/10

Item No.	Width mm	Depth mm	Height mm	Item No.
53771613	660	480	450	54771613
53771601	460	680	450	54771601
53771617	660	480	600	54771617
53771605	460	680	600	54771605
53771621	660	480	750	54771621
53771609	460	680	750	54771609

Top-mounted cabinet with hinged doors

Model SMFBA2

2 hinged doors
1 centre partition wall
2 handle elements
without equipment
for mounting ISO modules
of the size 600 x 400 mm

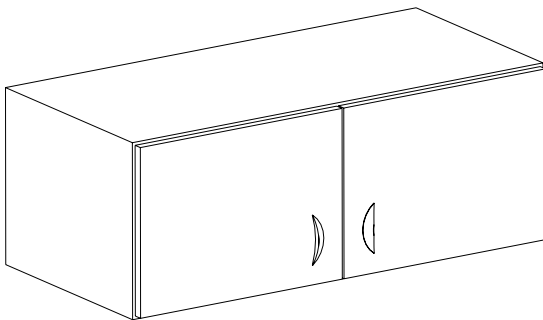

Powder-coated

CNS 18/10

Item No.	Width mm	Depth mm	Height mm	Item No.
53771707	1320	480	450	54771707
53771701	920	680	450	54771701
53771709	1320	480	600	54771709
53771703	920	680	600	54771703
53771711	1320	480	750	54771711
53771705	920	680	750	54771705

Module equipment

Multifunctional guide element

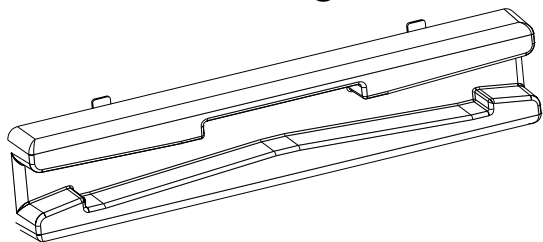

U-profile guide rail made of polyamide, grey white RAL 9002, with 2 fastening elements made of CNS 1.4301

Polyamide

Item No.	Description
343954	for DIN and ISO cabinets with 380 mm cabinet depth Length: 290 mm
343953	for ISO cabinets with 480 mm cabinet depth Length: 390 mm
343952	for DIN cabinets with 580 mm cabinet depth Length: 490 mm
343951	for ISO cabinets with 680 mm cabinet depth Length: 590 mm

Multifunctional telescopic slide

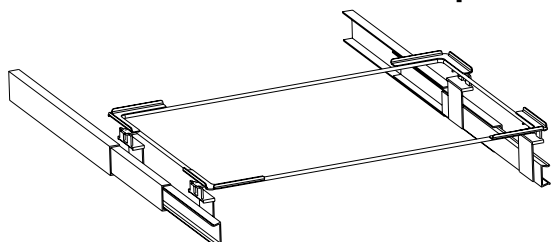

Metal guides with 2 fastening elements made of CNS, ball-bearing roller guide with pull-in mechanism and end lock, over-extension, universal holding frame made of CNS, surface electropolished, maximum loadability of telescopic slide is 30 kg

CNS 18/10

Item No.	Description
542385	for ISO cabinets with 480 mm depth Guide length: 383 mm, can be pulled out to 450 mm
542384	for ISO cabinets with 680 mm depth Guide length: 583 mm, can be pulled out to 650 mm

STU high cabinet

STU high cabinet with inner frame

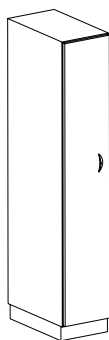

Model CMFBHG1

with CNS inner frame for mounting STU storage components, STU containers or STU baskets
with hinged door, left or right-hand hinging, double-walled sandwich design, cabinet without inside equipment, 1 handle element for 1 x 5.5 STU

Powder-coated

CNS 18/10

Item No.	Width mm	Depth mm	Height mm	Item No.
542931	400	680	2100	542933

STU high cabinet with inner frame

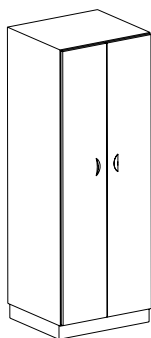

Model CMFBHG2

with CNS inner frame for mounting STU storage components, STU containers or STU baskets, with 2 hinged doors, double-walled sandwich design, cabinet without inside equipment, 2 handle elements

Powder-coated

Item No.	Width mm	Depth mm	Height mm	Description
54293201	730	680	2100	for 2 x 5.5 STU with 3 CNS inner frames
54293202	1060	680	2100	for 3 x 5.5 STU with 4 CNS inner frames

CNS 18/10

Item No.	Width mm	Depth mm	Height mm	Description
54293401	730	680	2100	for 2 x 5.5 STU with 3 CNS inner frames
54293402	1060	680	2100	for 3 x 5.5 STU with 4 CNS inner frames

STU high cabinet

STU high cabinet with hinged door

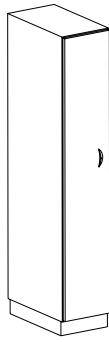

Model CMFBH1

suitable for holding
STU containers or baskets,
1 hinged door, left or right-hand hinging
1 handle element
without inside equipment

Powder-coated

CNS 18/10

Item No.	Width mm	Depth mm	Height mm	Item No.
53772101	375	680	2100	54772101

STU high cabinet with hinged doors

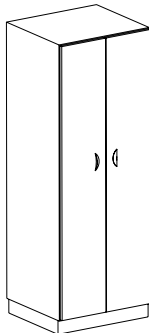

Model CMFBH2

suitable for holding
STU containers or baskets,
2 hinged doors
1 centre partition wall
2 handle elements
without inside equipment

Powder-coated

CNS 18/10

Item No.	Width mm	Depth mm	Height mm	Item No.
53772201	750	680	2100	54772201

Roll-in and pass-through cabinets

Roll-in cabinet

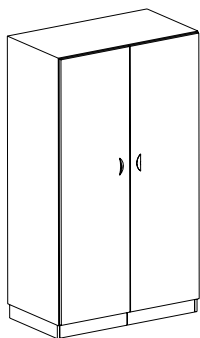

Model MFBHEE2

2 hinged doors with attached plinth

2 handle elements

Inside roll-in dimensions:

1080 x 820 x 2030 mm (W x D x H)

Powder-coated

CNS 18/10

Item No.	Width mm	Depth mm	Height mm	Item No.
53762901	1200	920	2100	54762901

Roll-in pass-through cabinet

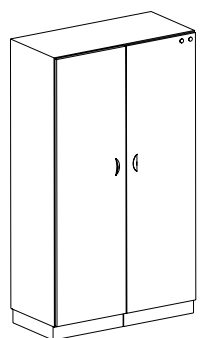

Model MFBHDF2

2 x 2 opposing hinged doors with attached plinth and electromagnetic locking

4 handle elements

Inside roll-in dimensions:

1080 x 820 x 2030 mm (W x D x H)

Powder-coated

CNS 18/10

Item No.	Width mm	Depth mm	Height mm	Item No.
54239701	1200	920	2100	54238601

Roll-in and pass-through cabinets

Pass-through cabinet

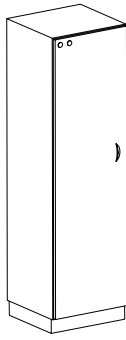

Model MFBDRH1

2 opposing hinged doors, left or right-hand hinging
2 handle elements
with mutual electromagnetic locking

Powder-coated

CNS 18/10

Item No.	Width mm	Depth mm	Height mm	Item No.
54200505	460	700	2100	54200805
54200501	600	700	2100	54200801

Pass-through cabinet

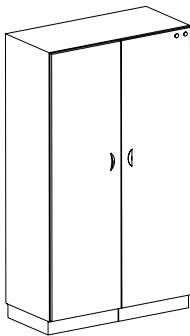

Model MFBDRH2

2 x 2 opposing hinged doors
4 handle elements
with mutual electromagnetic locking
Shelves optional

Powder-coated

CNS 18/10

Item No.	Width mm	Depth mm	Height mm	Item No.
54200603	900	700	2100	54200703
54200601	1200	700	2100	54200701

Roll-in and pass-through cabinets

Pass-through cabinet

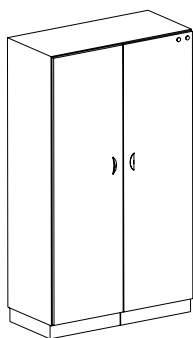

Model MFBDRH2 MW

2 x 2 opposing hinged doors
Centre partition wall
4 handle elements
with mutual electromagnetic locking
Shelves optional

Powder-coated

CNS 18/10

Item No.	Width mm	Depth mm	Height mm	Item No.
543052	1200	700	2100	542438

Pass-through cabinet

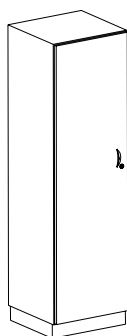

Model MFBHDR1

2 opposing hinged doors, left or right-hand hinging,
lockable
Shelves optional

Powder-coated

Item No.	Width mm	Depth mm	Height mm	Description
54239505	460	700	2100	2 handles, key-operated espagnolette bolt lock
54239511	460	700	2100	with espagnolette bolt lock with rotary olive knob
54239501	600	700	2100	2 handles, key-operated espagnolette bolt lock
54239509	600	700	2100	with espagnolette bolt lock with rotary olive knob

CNS 18/10

Item No.	Width mm	Depth mm	Height mm	Description
54236705	460	700	2100	2 handles, key-operated espagnolette bolt lock
54236711	460	700	2100	with espagnolette bolt lock with rotary olive knob
54236701	600	700	2100	2 handles, key-operated espagnolette bolt lock
54236709	600	700	2100	with espagnolette bolt lock with rotary olive knob

Roll-In and Pass-Through Cabinets

Pass-through cabinet

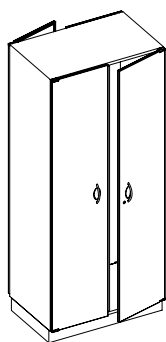

Model MFBDRH2 MW

2 x 2 opposing hinged doors, lockable

Powder-coated

Item No.	Width mm	Depth mm	Height mm	Description
54239603	900	700	2100	4 handle elements, key-operated espagnolette bolt lock
54239606	900	700	2100	with espagnolette bolt lock with rotary olive knob
54239601	1200	700	2100	4 handle elements, key-operated espagnolette bolt lock
54239605	1200	700	2100	with espagnolette bolt lock with rotary olive knob

CNS 18/10

Item No.	Width mm	Depth mm	Height mm	Description
54239403	900	700	2100	4 handle elements, key-operated espagnolette bolt lock
54239406	900	700	2100	with espagnolette bolt lock with rotary olive knob
54239401	1200	700	2100	4 handle elements, key-operated espagnolette bolt lock
54239405	1200	700	2100	with espagnolette bolt lock with rotary olive knob

Pass-through compartment system

Pass-through cabinet

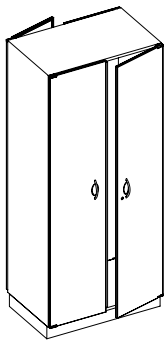

Model MFBHDR2 MW

2 x 2 opposing hinged doors,
centre partition wall, lockable

Powder-coated

Item No.	Width mm	Depth mm	Height mm	Description
54243501	1200	700	2100	Centre partition wall, 4 handle elements, key-operated espagnolette bolt lock
54243505	1200	700	2100	Centre partition wall, espagnolette bolt lock with rotary olive knob

CNS 18/10

Item No.	Width mm	Depth mm	Height mm	Description
5424301	900	700	2100	Centre partition wall, 4 handle elements, key-operated espagnolette bolt lock
5424305	900	700	2100	Centre partition wall, espagnolette bolt lock with rotary olive knob

Pass-through compartment system

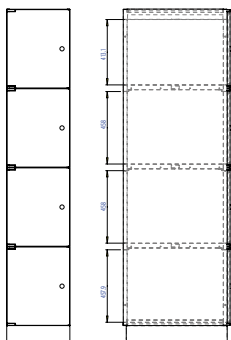

Model MDF

for STU dimensions, self-supporting sturdy design,
suitable for installation in wall openings or as
room divider

Design:

4 compartments, 1 hinged door per compartment at
front, right or left-hand hinging,
lockable with rotary olive knob,
inside compartment dimensions: 350 x 625 x 455 mm

Powder-coated

Item No.	Width mm	Depth mm	Height mm	Description	CNS 18/10 Item No.
54311201	400	680	2100	Rear open	53799801
54311202	400	700	2100	Rear with hinged door	53799802

Pass-through compartment system

Pass-through compartment system

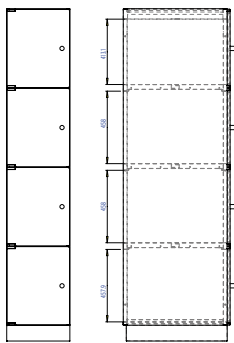

Model MDFE

for STU dimensions, self-supporting sturdy design, suitable for installation in wall openings or as room divider

Design:

4 compartments, 1 hinged door with rotary olive knob per compartment at front, right or left-hand hinging, one hinged door at rear, mutual electromagnetic locking

inside compartment dimensions: 350 x 625 x 455 mm
Top compartment 410 mm high.

Powder-coated

CNS 18/10

Item No.	Width mm	Depth mm	Height mm	Description	Item No.
543071	400	700	2100	Rear open	542418

Pass-through compartment system

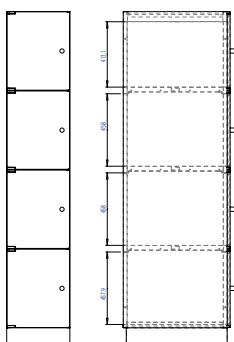

Model SMDF

for ISO dimensions, self-supporting sturdy design, suitable for installation in wall openings or as room divider

Design:

4 compartments, 1 hinged door with rotary olive knob per compartment at front, right or left-hand hinging

Compartment dimensions: 410 x 625 x 455 mm
With electr. locking, top compartment 410 mm high

Powder-coated

CNS 18/10

Item No.	Width mm	Depth mm	Height mm	Description	Item No.
54311301	460	680	2100	Rear open	53799901
54311302	460	700	2100	Rear with hinged door	53799902

Cover frame

for flush wall installation

Powder-coated

CNS 18/10

Item No.	Item No.
602133	602134

STU accessories

Locking device

mutual electromagnetic locking

Item No.	Description
34045701	Locking device for 1 compartment row (4 compartments vertically with door opposite)
34045702	Locking device for 2 doors with two opposing doors (regardless of the number of shelves) for pass-through compartment system and pass-through cabinet

STU angled support brackets

for hooking in pins, for STU cabinets with inner frame, STU shelf and container transport trolley.
For storing containers and sterile product baskets.

CNS 18/10

Item No.	Width mm	Depth mm	Height mm
542889	60	600	50

Perforated shelf

for hooking in pins, for STU cabinets with inner frame and STU shelf.
For storing containers and sterile product baskets.

CNS 18/10

Item No.
600777

Closed shelf

for hooking in pins, for STU cabinets with inner frame and STU shelf.
For storing containers and sterile product baskets.

CNS 18/10

Item No.
600778

STU Accessories

STU heavy-load extension

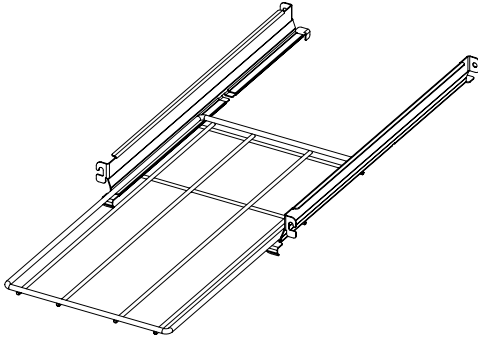

for storing containers and sterile product baskets. Consisting of 1 rotary shelf and 2 angled support brackets with synthetic sliding rail, with 2/3 extension and pull-out stop, for hanging. Max. load-bearing capacity 25 kg.

CNS 18/10

Item No.	Width mm	Depth mm	Description
542529	292	600	for hooking in pins, for STU cabinets with inner frame, STU shelf and container transport trolley.
542952	292	600	for STU cabinet with laid-on slotted grid rails, with shelf carrier

Tray for STU extension

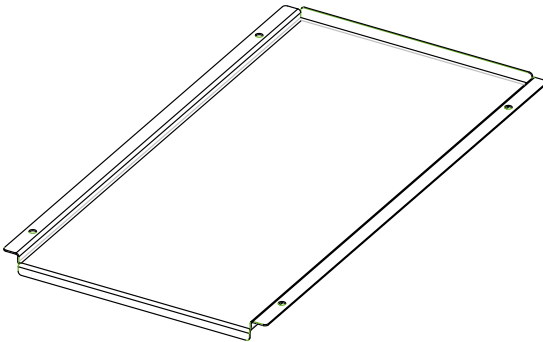

for STU cabinet with slotted grid rails incl. guide pair

CNS 18/10

Item No.
602162

Plinth

System plinth

Powder-coated

CNS 18/10

Item No.	Cabinet depth mm	Item No.
543104	400-680	543105

Metal plinth plate

Powder-coated

CNS 18/10

Item No.	Item No.
MC0138	MC0140

Base frame

CNS 18/10

Item No.	Height mm
548532	150 - 250

Individual cabinet plinth

Powder-coated

CNS 18/10

Item No.	Width mm	Cabinet depth mm	Item No.
MC0148	450/460	557/657	MC0152
MC0149	600/660	557/657	MC0153
MC0150	900/920	557/657	MC0154
MC0151	1200/1320	557/657	MC0155

Individual cabinet plinth, can be levelled

Powder-coated

CNS 18/10

Item No.	Width mm	Cabinet depth mm	Item No.
MC0158	450/460	557/657	MC0162
MC0159	600/660	557/657	MC0163
MC0160	900/920	557/657	MC0164
MC0161	1200/1320	557/657	MC0165

Cabinet shelf

ISO cabinet shelf

for use with multifunction guide element and telescopic slide

Wood/Synthetic

Shelf Dimension

Item No.	Width mm	Depth mm	Height mm
344493	600	400	12

ISO cabinet shelf for support wall

on underside with 4-sided inward flanging

Powder-coated

Shelf dimension

CNS 18/10

Item No.	Width mm	Depth mm	Height mm	Item No.
602136	600	400	12	602137

Wood/synthetic

Shelf dimension

Item No.	Width mm	Depth mm	Height mm
542996	600	400	12

ISO cabinet shelf for cabinet with 660 x 480 mm slotted grid

with shelf carrier set

Powder-coated

Shelf dimension

CNS 18/10

Item No.	Width mm	Depth mm	Height mm	Item No.
602138	613	407	25	602139
MC0200	413	607	25	MC0201

Wood/synthetic

Item No.	Width mm	Depth mm	Height mm
542997	613	407	21

Cabinet shelf

Cabinet shelf with shelf carrier set

for base, top-mounted and high cabinet, 580 mm deep

Wood/synthetic

Item No.	Width mm	Depth mm
53798001	450	557
53798002	600	557
53798003	900	557
53798004	1200	557

Cabinet shelf with shelf carrier set

for base, top-mounted and high cabinet, 580 mm deep, single-walled

Powder-coated

CNS 18/10

Item No.	Width mm	Depth mm	Item No.
53798601	450	557	53793201
53798602	600	557	53793202
53798603	900	557	53793203
53798604	1200	557	53793204

Cabinet shelf with shelf carrier set

for wall cabinet, 300/380 mm deep

Wood/synthetic

Item No.	Width mm	Depth mm
53798005	450	277/357
53798006	600	277/357
53798007	900	277/357
53798008	1200	277/357

Cabinet shelf with shelf carrier set

for wall cabinet, 300/380 mm deep, single-walled

CNS 18/10

Item No.	Width mm	Depth mm	Item No.
53798605	450	277/357	53793205
53798606	600	277/357	53793206
53798607	900	277/357	53793207
53798608	1200	277/357	53793208

Cabinet shelf

Cabinet shelf with shelf carrier set

for base, top-mounted and high cabinet, 580 mm deep, double-walled

Powder-coated

CNS 18/10

Item No.	Width mm	Depth mm	Item No.
53798701	450	557	53798501
53798702	600	557	53798502
53798703	900	557	53798503
53798704	1200	557	53798504

Cabinet shelf with shelf carrier set

for wall cabinet, 300/380 mm deep, double-walled

Powder-coated

CNS 18/10

Item No.	Width mm	Depth mm	Item No.
53798705	450	277/357	53798505
53798706	600	277/357	53798506
53798707	900	277/357	53798507
53798708	1200	277/357	53798508

Cabinet shelf with shelf carrier set

Glass

Item No.	Width mm	Depth mm	Description
53798301	450	277/357	for wall cabinet, 300/380 mm deep
53798302	600	277/357	for wall cabinet, 300/380 mm deep
53798303	900	277/357	for wall cabinet, 300/380 mm deep
53798304	1200	277/357	for wall cabinet, 300/380 mm deep
53798309	600	457	for practice cabinet, 480 mm deep
53798310	1200	457	for practice cabinet, 480 mm deep

Shelf

Shelf securely screwed on

for 600 mm wide cabinet incl. mounting

Steel sheet

Item No.	Description
343466	single-walled
602156	double-walled

CNS 18/10

Item No.	Description
601347	single-walled
602157	double-walled

Waste collector, round

for installation in base cabinet

Item No.	Volume	Description
602153	11 ltr.	CNS with stainless steel lid, incl. mounting, 11 litres

Light screens and accessories

Thebo lamp

with glare protection

White

Item No.	Width mm	Description
604501	321	Underframe lamp model R3200, 8 W
604502	470	Underframe lamp model R3200, 15 W
604509	625	Underframe lamp model R3200, 18 W
604503	753	Underframe lamp model R3200, 16 W
604504	927	Underframe lamp model R3200, 30 W

CNS

Item No.	Width mm	Description
604505	321	Underframe lamp model R3200, 8 W
604506	470	Underframe lamp model R3200, 15 W
604510	625	Underframe lamp model R3200, 18 W
604507	753	Underframe lamp model R3200, 16 W
604508	927	Underframe lamp model R3200, 30 W

Light screens without lighting

Powder-coated

Item No.	Height mm	Description
538333	100	straight
538334	100	L-shaped
538335	100	U-shaped

CNS 18/10

Item No.	Height mm	Description
538333	100	straight
538334	100	L-shaped
538335	100	U-shaped

Light screens and accessories

Light screens with switch and without lighting

Powder-coated

Item No.	Description
543039	straight
543040	L-shaped
543041	U-shaped

CNS 18/10

Item No.	Description
543042	straight
543044	L-shaped
543043	U-shaped

Locking socket

white, for Thebo lamp

Item No.	Description
601497	Locking socket
601947	Plug for locking socket

Light screens and accessories

Connection unit

for Thebo lamp, 100 mm long

Item No.	Description
601501	white
601502	CNS

Connection unit with switch

for Thebo lamp, 130 mm long

Item No.	Description
604511	white
604512	CNS

Connection cable for plug coupling

for Thebo lamp

Item No.	Description
601498	Plug coupling, cable 200 mm
601499	Plug coupling, cable 500 mm
601500	Plug coupling, cable 2000 mm

Cabinet unit

STL centre partition wall

when retrofitting double-door cabinets, a new left-hand cabinet door is required.

Powder-coated

Item No.	Description
602145	for high cabinet, 557 x 2000 mm, with slotted grid, mounted
602146	for high cabinet, 557 x 750 mm, with slotted grid, mounted
602147	for high cabinet, 357 x 7500 mm, with slotted grid, including mounting

CNS centre partition wall

when retrofitting double-door cabinets, a new left-hand cabinet door is required.

CNS 18/10

Item No.	Description
602145	for high cabinet, 557 x 2000 mm, with slotted grid, mounted
602146	for high cabinet, 557 x 750 mm, with slotted grid, mounted
602147	for high cabinet, 357 x 7500 mm, with slotted grid, including mounting

Drawer

Drawer

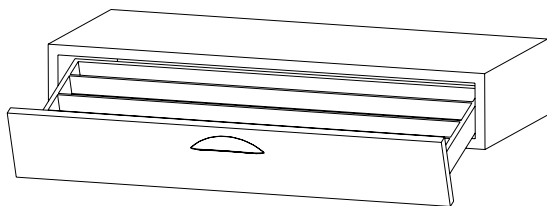

Model MSF-L

for mounting below wall cabinets, fold-out, synthetic inserts with longitudinal division for catheters, complete with lighting, (with compensation screen for cabinet depth of 380 mm)

Powder-coated

CNS 18/10

Item No.	Width mm	Depth mm	Item No.
53613401	900	300	54613404
53613402	920	300	54613405
53613403	1200	300	54613406
53613407	900	380	54613410
53613408	920	380	54613411
53613409	1200	380	54613412

Drawer

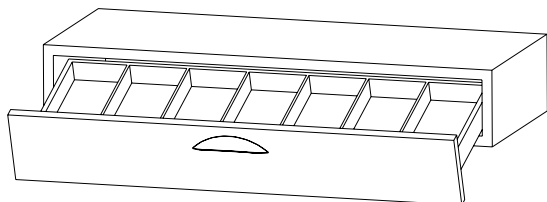

Model MSF-Q

for mounting below wall cabinets, fold-out, synthetic inserts with lateral division for syringes and needles, complete with lighting, (with compensation screen for cabinet depth of 380 mm)

Powder-coated

CNS 18/10

Item No.	Width mm	Depth mm	Item No.
53613413	900	300	54613416
53613414	920	300	54613417
53613415	1200	300	54613418
53613419	900	380	54613422
53613420	920	380	54613423
53613421	1200	380	54613424

Drawer divider

Drawer divider made of Plexiglas for metal drawers, 150 mm high

Divider movable and removable, sets consisting of longitudinal and lateral dividers, L and T-clips

Plexiglas

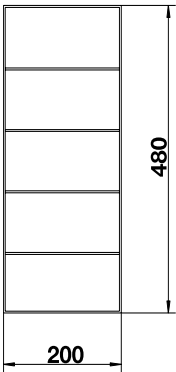
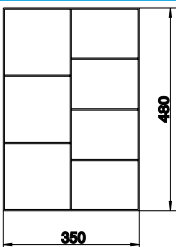
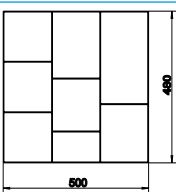
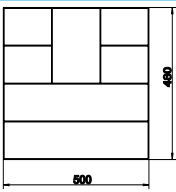
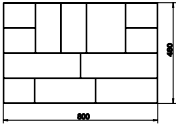
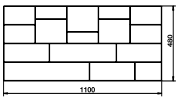
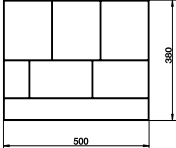
	Item No.	Description
	542399	Model 001 suitable for a drawer depth of 480 mm, cabinet depth of 580 mm and cabinet width of 300 mm
	542400	Model 002 suitable for a drawer depth of 480 mm, cabinet depth of 580 mm and cabinet width of 450 mm
	542401	Model 004A suitable for a drawer depth of 480 mm, cabinet depth of 580 mm and cabinet width of 600 mm
	542402	Model 004B suitable for a drawer depth of 480 mm, cabinet depth of 580 mm and cabinet width of 600 mm
	542403	Model 006 suitable for a drawer depth of 480 mm, cabinet depth of 580 mm and cabinet width of 900 mm
	542404	Model 007 suitable for a drawer depth of 480 mm, cabinet depth of 580 mm and cabinet width of 1200 mm
	542405	Model 008 suitable for a drawer depth of 380 mm, cabinet depth of 480 mm and cabinet width of 660 mm

Drawer divider

Drawer divider made of Plexiglas for metal drawers, 450 mm wide

Divider movable and removable, sets consisting of longitudinal and lateral dividers, L and T-clips

Plexiglas

Item No.	Width mm	Depth mm	Height mm	Description
542999	345	477	40	Model 021, for screen height of 75 mm Consisting of: 2 universal rails made of acrylic, 342 x 35 mm, 3x universal rails made of acrylic, 459 x 35 mm, 2x T-clip, 2 pairs of L-clips left & right, 7x sliding dividers UT, 7x L-clips right for securing sliding dividers
543000	345	477	40	Model 022, for screen height of 100 mm Consisting of: 2 universal rails made of acrylic, 342 x 35 mm, 3x universal rails made of acrylic, 459 x 35 mm, 2x T-clip, 2 pairs of L-clips left & right, 7x sliding dividers UT, 7x L-clips right for securing sliding dividers
543001	345	477	67	Model 023, for screen height of 150 mm Consisting of: 2 universal rails made of acrylic, 342 x 57 mm; 3x universal rails made of acrylic, 459 x 57 mm, 2x T-clip, 2 pairs of L-clips left & right, 7x sliding dividers UT, 7x L-clips right for securing sliding dividers

Drawer divider made of Plexiglas for metal drawers, 600 mm wide

Divider movable and removable, sets consisting of longitudinal and lateral dividers, L and T-clips

Plexiglas

Item No.	Width mm	Depth mm	Height mm	Description
543002	495	477	40	Model 024, for screen height of 75 mm Consisting of: 2 universal rails made of acrylic, 492 x 35 mm; 4x universal rails made of acrylic, 459 x 35 mm, 4x T-clip, 2 pairs of L-clips left & right, 8x sliding dividers UT, 8x L-clips right for securing sliding dividers
543003	495	477	40	Model 025, for screen height of 100 mm Consisting of: 2 universal rails made of acrylic, 492 x 35 mm; 4x universal rails made of acrylic, 459 x 35 mm, 4x T-clip, 2 pairs of L-clips left & right, 8x sliding dividers UT, 8x L-clips right for securing sliding dividers
543004	495	477	67	Model 026, for screen height of 150 mm Consisting of: 2 universal rails made of acrylic, 492 x 57 mm; 4x universal rails made of acrylic, 459 x 57 mm, 4x T-clip, 2 pairs of L-clips left & right, 8x sliding dividers UT, 8x L-clips right for securing sliding dividers

Drawer divider

Drawer divider made of Plexiglas for metal drawers, 900 mm wide

Divider movable and removable, sets consisting of longitudinal and lateral dividers, L and T-clips

Plexiglas

Item No.	Width mm	Depth mm	Height mm	Description
543008	795	377	43	Model 030, for drawer depth of 480 mm, for screen height of 100 mm Consisting of: 2 universal rails made of acrylic, 792 x 35 mm; 7 universal rails made of acrylic, 359 x 35 mm, 10 x T-clip, 2 pairs of L-clips left & right, 18 sliding dividers UT, 18 x L-clips right for securing sliding dividers
543005	795	477	43	Model 027, for drawer depth of 580 mm, for screen height of 100 mm Consisting of: 2 universal rails made of acrylic, 792 x 35 mm; 9x universal rails made of acrylic, 459 x 35 mm, 14x T-clip, 2 pairs of L-clips left & right, 24x sliding dividers UT, 24x L-clips right for securing sliding dividers
543009	795	377	70	Model 031, for drawer depth of 480 mm, for screen height of 150 mm Consisting of: 2 universal rails made of acrylic, 792 x 57 mm; 6x universal rails made of acrylic, 359 x 57 mm, 10x T-clip, 8 pairs of L-clips left & right, 15x sliding dividers UT, 15x L-clips right for securing sliding dividers
543006	795	477	70	Model 028, for drawer depth of 580 mm, for screen height of 150 mm Consisting of: 2 universal rails made of acrylic, 792 x 57 mm; 6x universal rails made of acrylic, 459 x 35 mm, 8x T-clip, 2 pairs of L-clips left & right, 15x sliding dividers UT, 15x L-clips right for securing sliding dividers
543010	795	377	102	Model 032, for drawer depth of 480 mm, for screen height of 200 mm Consisting of: 2 universal rails made of acrylic, 792 x 100 mm; 6x universal rails made of acrylic, 359 x 100 mm, 8x T-clip, 2 pairs of L-clips left & right, 10x sliding dividers UT, 10x L-clips right for securing sliding dividers
543007	795	477	102	Model 029, for drawer depth of 580 mm, for screen height of 200 mm Consisting of: 4 universal rails made of acrylic, 777 x 100 mm; 2x universal rails made of acrylic, 474 x 100 mm, 4x T-clip, 2 pairs of L-clips left & right, 4x sliding dividers UT, 4x L-clips right for securing sliding dividers

Drawer divider

Drawer divider made of Plexiglas for metal drawers, 1200 mm wide

Divider movable and removable, sets consisting of longitudinal and lateral dividers, L and T-clips

Plexiglas

Item No.	Width mm	Depth mm	Height mm	Description
543014	1095	377	43	Model 036, for drawer depth of 480 mm, for screen height of 100 mm Consisting of: 4 universal rails made of acrylic, 1077 x 35 mm; 2x universal rails made of acrylic, 374 x 35 mm, 4x T-clip, 2 pairs of L-clips left & right, 12x sliding dividers UT, 12x L-clips right for securing sliding dividers
543011	1095	477	43	Model 033, for drawer depth of 580 mm, for screen height of 100 mm Consisting of: 12 universal rails made of acrylic, 1092 x 35 mm; 8x universal rails made of acrylic, 459 x 35 mm, 12x T-clip, 2 pairs of L-clips left & right, 18x sliding dividers UT, 18x L-clips right for securing sliding dividers
543015	1095	377	70	Model 037, for drawer depth of 480 mm, for screen height of 150 mm Consisting of: 4 universal rails made of acrylic, 1077 x 57 mm; 2x universal rails made of acrylic, 374 x 57 mm, 4x T-clip, 2 pairs of L-clips left & right, 6x sliding dividers UT, 6x L-clips right for securing sliding dividers
543012	1095	477	70	Model 034, for drawer depth of 580 mm, for screen height of 150 mm Consisting of: 2 universal rails made of acrylic, 1092 x 57 mm; 7x universal rails made of acrylic, 459 x 57 mm, 10x T-clip, 2 pairs of L-clips left & right, 18x sliding dividers UT, 18x L-clips right for securing sliding dividers
543016	1095	377	102	Model 038, for drawer depth of 480 mm, for screen height of 200 mm Consisting of: 3 universal rails made of acrylic, 1077 x 100 mm; 2x universal rails made of acrylic, 374 x 100 mm, 2x T-clip, 2 pairs of L-clips left & right, 2x sliding dividers UT, 2x L-clips right for securing sliding dividers
543013	1095	477	102	Model 035, for drawer depth of 580 mm, for screen height of 200 mm Consisting of: 4 universal rails made of acrylic, 1077 x 100 mm; 2x universal rails made of acrylic, 474 x 100 mm, 4x T-clip, 2 pairs of L-clips left & right, 3x large dividers UT, 3x L-clips right for securing sliding dividers

BTM safe

Opiate BTM safe in accordance with VDMA 24992, safety level A, sheet steel, powder-coated

with grid rail, with cabinet shelf

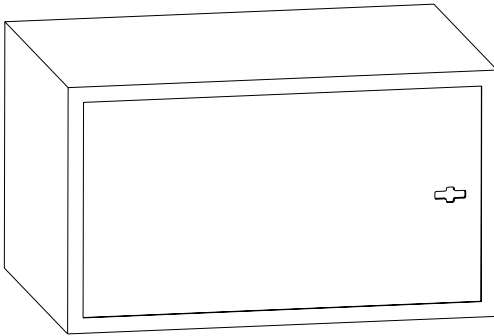



Powder-coated

Item No.	Width mm	Depth mm	Height mm	Description
246424	406	245	320	for wall cabinets left-hand hinging
246425	406	245	320	for wall cabinets right-hand hinging
246420	556	245	320	for wall cabinets left-hand hinging
246421	556	245	320	for wall cabinets right-hand hinging
246422	406	400	320	for high cabinets left-hand hinging
246423	406	400	320	for high cabinets right-hand hinging
246418	556	400	320	for high cabinets left-hand hinging
246419	556	400	320	for high cabinets right-hand hinging

BTM safe in accordance with EN 1143-1 model 103-03, BLANCO version

for high cabinets, with cabinet shelves

Powder-coated



	Item No.	Width mm	Depth mm	Height mm	Description
	542944	500	410	340	right-hand hinging, inside dimensions: 416x295x230 mm (W x D x H), weight: 95 kg
	601364	500	410	340	left-hand hinging, inside dimensions: 416x295x230 mm (W x D x H), weight: 95 kg

BTM safe

BTM safe in accordance with EN 1143-1 model 103-01, BLANCO version

for high cabinets, with cabinet shelves

Powder-coated

	Item No.	Width mm	Depth mm	Height mm	Description
	601365	400	400	340	left-hand hinging, inside dimensions: 316x270x230 mm (W x D x H), weight: 80 kg
	542943	400	400	340	right-hand hinging, inside dimensions: 316x270x230 mm (W x D x H), weight: 80 kg

Spare key for BTM safe according to sample

Item No.	Description
601791	for BTM safes in accordance with EN 1143-1

Spare key for BTM safe

Item No.	Description
601336	for BTM key with Key No.

Shelf for BTM safe

Powder-coated

Item No.	Description
602140	for BTM Safe No. 542944 and 601364
602141	for BTM Safe No. 542943 and 601365

Accessories

Hook strip for inside of door

in conjunction with shortened shelves

CNS 18/10

Item No.	Width mm
242055	300
242056	450

Drug stairs for high cabinets - two-step

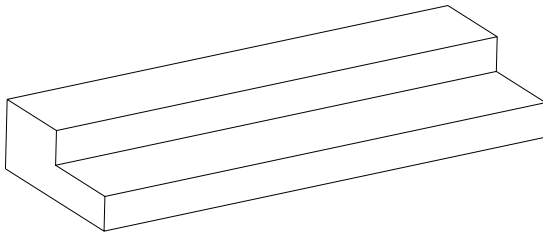

Powder-coated

Item No.	Width mm	Depth mm	Height mm
53799301	450	160	80
53799302	600	160	80
53799303	900	160	80
53799304	1200	160	80

Drug stairs for high cabinets - three-step

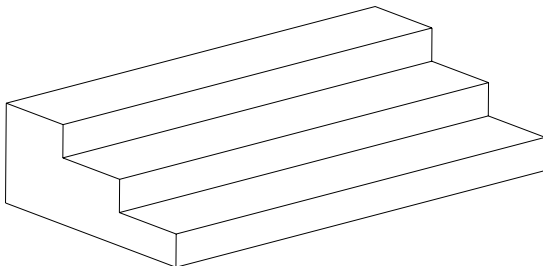

Powder-coated

Item No.	Width mm	Depth mm	Height mm
53809901	450	300	120
53809902	600	300	120
53809903	900	300	120
53809904	1200	300	120

Accessories

File rack

Item No.	Width mm	Description
344204	450	Mounting of a file rack in an extension, 450 mm wide, complete frame
344273	450	Mounting of a file rack in an extension, 450 mm wide above lateral
344276	450	Mounting of a file rack in an extension, 450 mm wide above longitudinal

Angled support

stackable, made of synthetic, black
required quantity dependent on drawer height

Item No.	Width mm	Depth mm	Height mm
543019	328	212	35

Door limiter incl. mounting

Item No.	Description
345565	for high cabinet/wall cabinet
345567	for base cabinet

Clothes rod

mounted for high cabinet, consisting of oval clothes rod, chrome-plated with 2 mounts

Item No.
602163

Ventilation grate for cabinet door

synthetic

Item No.
247098

Accessories

Telescopic extension with angled mount, screwed on

Item No.	Description
543020	Full extension, installation length 500 mm
543021	Full extension, installation length 600 mm

Desk utensil insert

with 8 compartments for use in pull-out worktop

Item No.	Width mm	Depth mm	Height mm
145654	277	277	6

Shelf securely screwed on

for 600 mm wide cabinet incl. mounting

Steel sheet

Item No.	Description
343466	single-walled
602156	double-walled

CNS 18/10

Item No.	Description
601347	single-walled
602157	double-walled

Inner drawer

Powder-coated

Item No.	Width mm	Height mm	Description
602143	1200	60	for 1200 mm wide high cabinets
602144	1200	100	for 1200 mm wide high cabinets

Accessories

Intermediate cross-member for base cabinet drawers

Powder-coated

Item No.	Width mm
331553	600
331554	900
331555	1200

Pull out worktop below a cabinet shelf

for cabinet depth of 580 mm (dimensions = outside dimension incl. bracket)

Duropol

Item No.	Width mm	Depth mm	Height mm
537958	511	512	16

Espagnolette lock for high cabinet

Item No.	Description
340562	Key operation
340563	with rotary olive knob

Lever lock for base or wall cabinet door or individual drawer

Item No.
340564

Central locking for drawer block

Item No.
542023

Angular U-handle

CNS 18/10

Item No.
146708

Warming drawer

Warming drawer for infusions



with perforated bottom, switch panel and LED display for display of inside temperature.

Capacity: Drawer 450 mm wide: 12 x 1 l or 20 x 0.5 ltr. bottles; drawer 600 mm: 20 x 1 ltr. or 32 x 0.5 ltr. bottles; drawer 660 mm wide: 24 x 1 ltr. or 36 x 0.5 ltr. bottles

Temperature adjustable from +33 °C to +37 °C, set to + 37 °C at factory, overtemperature protection at 46 °C, self-limiting PTC heating element, connected load: 220 - 240 V AC, 50 - 60 Hz, 400 W, 1.7 A, frame height 233 mm, loading height: screen height minus 50 mm, Class 2a medical product

Powder-coated

CNS 18/10

Item No.	Width mm	Depth mm	Height mm	Connection	Item No.
34678401	450 - 660	580 - 680	350 - 375	Connected load: 220 - 240 V AC, 50 - 60 Hz, 400 W, 1.7 A	34678402

Warming drawer for linens



with perforated bottom, switch panel and LED display for display of inside temperature.

Temperature adjustable from 40 °C to 65 °C, overtemperature protection, self-limiting PTC heating element, mains connection: 220 - 240 V AC, 50 - 60 Hz, power consumption 400 W, 1.7 A, frame height 233 mm, loading height: screen height minus 50 mm

Powder-coated

CNS 18/10

Item No.	Width mm	Depth mm	Height mm	Connection	Item No.
54306401	450 - 660	580 - 680	350 - 375	Connected load: 220 - 240 V AC, 50 - 60 Hz, 400 W, 1.7 A	54306402

Refrigeration units

KUw 1544 Premium refrigerator



Decorateable Liebherr KUw 1544 base refrigerator - gross/usable content 137/132 ltr. - 3-star freezer compartment with ice cube tray- automatic defroster in refrigeration section - "glass-line" placement surfaces (1 of which is dividable) - "glass-line" shelf - butter/cheese compartment- butter box - bottle/can holder - energy consumption: 237.5 kWh in 365 days - energy efficiency class A - niche dimensions in cm: 82 x 60 x 57 mm (H x W x D)

Item No.	Description
145499	left-hand hinging
145500	right-hand hinging

EK 1514 Comfort refrigerator



Decorateable EK 1514 built-in refrigerator - gross/usable content 127/121 ltr.

Item No.	Description
146099	3-star freezer compartment with ice cube tray - energy consumption: 193.4 kWh in 365 days - energy efficiency class A+ - niche dimensions in cm: 87.4 - 87.8 x 56-57 x at least 55 (H x W X D)

Refrigeration units

MED-85 drug refrigerator



Kirsch MED-85 drug refrigerator for built-in and under-surface mounting

Item No.	Description
145710	Cooling capacity 80 ltr. - normal consumption 0.5 kWh/24 h - exterior dimensions without table top 47 x 51 x 74 mm (W x D x H)

MED-100 drug refrigerator



Kirsch MED-100 drug refrigerator, cooling capacity 95 ltr., for built-in and under-surface mounting

Item No.	Description
247348	Normal consumption 0.35 kWh/24 h Exterior dimension without table top 54 x 53 x 82 mm (W x D x H)

Refrigeration units

MED125 drug refrigerator



Kirsch MED-125 drug refrigerator, cooling capacity 120 litres, normal consumption 0.6 kWh/24 h, for built-in and under-surface mounting. Max. load: drawer/grate 13 kg/25 kg. Weight: net 40 kg, gross 48 kg. Interior drawer dimensions: 40.8 cm wide, 32 cm deep, 5.6 cm high. Grate size: 43.8 x 24 cm Interior dimensions: 44 cm wide, 42 cm deep, 67 cm high (usable depth above 5 cm, below 15 cm less, usable width 2 cm less)

Item No.	Width mm	Depth mm	Height mm	Description
600933	540	535	810	left-hand hinging
600934	540	535	810	right-hand hinging

FROSTER-MED-70 freezer



Kirsch FROSTER-MED-70 freezer, cooling capacity 70 ltr., for built-in and under-surface mounting - normal consumption 1.6 kWh/24 h - exterior dimensions without table top 47 x 51 x 74 mm (W x D x H)

Item No.

245910

Refrigeration units

FROSTER-MED-95 freezer



Kirsch FROSTER-MED-95 freezer, cooling capacity 95 ltr., for built-in and under-surface mounting - normal consumption 2.8 kWh/ 24 h - outside dimension without table top 54 x 53 x 82 mm (W x D x H)

Item No.

247349

BL-100 stored blood refrigerator



Kirsch BL-100 stored blood refrigerator for built-in and under-surface mounting

Item No.	Description
245911	Cooling capacity 95 ltr. - normal consumption 0.35 kWh/24 h - outside dimension without table top 54 x 53 x 82 mm (W x D x H)

Screens as per DIN and ISO standard, powder-coated

Screens for cabinets as per DIN and ISO standard, powder-coated

Powder-coated

Item No.	Width mm	Height mm	Description
54056901	450/460	up to 200	Ceiling screen with fastening materials, low
54056902	600/660	up to 200	Ceiling screen with fastening materials, low
54056903	900/920	up to 200	Ceiling screen with fastening materials, low
54056904	1200/1320	up to 200	Ceiling screen with fastening materials, low
54057901	450/460	up to 200	Ceiling screen, closed at bottom, with fastening materials
54057902	600/660	up to 200	Ceiling screen, closed at bottom, with fastening materials
54057903	900/920	up to 200	Ceiling screen, closed at bottom, with fastening materials
54057904	1200/1320	up to 200	Ceiling screen, closed at bottom, with fastening materials
54057001	450/460	200 - 900	Ceiling screen with fastening materials, high
54057002	600/660	200 - 900	Ceiling screen with fastening materials, high
54057003	900/920	200 - 900	Ceiling screen with fastening materials, high
54057004	1200/1320	200 - 900	Ceiling screen with fastening materials, high
54058001	450/460	200 - 900	Ceiling screen, closed at bottom, with fastening materials
54058002	600/660	200 - 900	Ceiling screen, closed at bottom, with fastening materials
54058003	900/920	200 - 900	Ceiling screen, closed at bottom, with fastening materials
54058004	1200/1320	200 - 900	Ceiling screen, closed at bottom, with fastening materials
540825	up to 300	up to 2100	High cabinet side screen/side wall extension with plinth piece
540582	up to 300	up to 2100	High cabinet side screen/side wall extension with top cover and plinth piece
540827	up to 300	up to 2100	High cabinet intermediate screen with top cover and plinth piece
540864	up to 300	up to 2100	High cabinet corner screen with plinth piece without top cover
540828	up to 300	up to 2100	High cabinet corner screen with plinth piece with top cover
540591		700 - 850	Base cabinet corner screen with plinth piece, low
540585	up to 300	700 - 850	Base cabinet side screen/side wall extension with plinth piece, low
540829	up to 300	700 - 850	Base cabinet intermediate screen with plinth piece, low
540834	up to 300	600 - 750	Wall cabinet corner screen, closed at top and bottom, low
540587	up to 300	600 - 750	Wall cabinet side/intermediate screen, low
54086601		up to 750	Rear wall trim panel for base cabinet
54086602		up to 2100	Rear wall trim panel for high cabinet
54086603		up to 750	Rear wall trim panel for top-mounted cabinet
540869		up to 650	Rear wall (niche panel) between table top and wall cabinet, made of CNS 18/10
540593		100	Plinth end piece

Screens as per DIN and ISO standard in CNS

Screens for cabinets as per DIN and ISO standard in CNS

CNS 18/10

Item No.	Width mm	Height mm	Description
53056901	450/460	up to 200	Ceiling screen with fastening materials, low
53056902	600/660	up to 200	Ceiling screen with fastening materials, low
53056903	900/920	up to 200	Ceiling screen with fastening materials, low
53056904	1200/1320	up to 200	Ceiling screen with fastening materials, low
53057901	450/460	up to 200	Ceiling screen, closed at bottom, with fastening materials
53057902	600/660	up to 200	Ceiling screen, closed at bottom, with fastening materials
53057903	900/920	up to 200	Ceiling screen, closed at bottom, with fastening materials
53057904	1200/1320	up to 200	Ceiling screen, closed at bottom, with fastening materials
53057001	450/460	200-900	Ceiling screen with fastening materials, high
53057002	600/660	200-900	Ceiling screen with fastening materials, high
53057003	900/920	200-900	Ceiling screen with fastening materials, high
53057004	1200/1320	200-900	Ceiling screen with fastening materials, high
53058001	450/460	200-900	Ceiling screen, closed at bottom, with fastening materials
53058002	600/660	200-900	Ceiling screen, closed at bottom, with fastening materials
53058003	900/920	200-900	Ceiling screen, closed at bottom, with fastening materials
53058004	1200/1320	200-900	Ceiling screen, closed at bottom, with fastening materials
530825	up to 300	up to 2100	High cabinet side screen/side wall extension with plinth piece
530582	up to 300	up to 2100	High cabinet side screen/side wall extension with top cover and plinth piece
530827	up to 300	up to 2100	High cabinet intermediate screen with top cover and plinth piece
530864	up to 300	up to 2100	High cabinet corner screen with plinth piece without top cover
530828	up to 300	up to 2100	High cabinet corner screen with plinth piece with top cover
530591		700-850	Base cabinet corner screen with plinth piece, low
530585	up to 300	700-850	Base cabinet side screen/side wall extension with plinth piece, low
530829	up to 300	700-850	Base cabinet intermediate screen with plinth piece, low
530587	up to 300	600-750	Wall cabinet side/intermediate screen, low
530834	up to 300	600-750	Wall cabinet corner screen, closed at top and bottom, low
53086501		up to 750	Rear wall trim panel for base cabinet
530866		up to 2100	Rear wall trim panel for high cabinet
53086502		up to 750	Rear wall trim panel for top-mounted cabinet
530869		up to 650	Rear wall (niche panel) between table top and wall cabinet
530593		100	Plinth end piece

Screens as per DIN and ISO standard

Ladder frame for high cabinet with top-mounted cabinet

Powder-coated

Item No.	Height mm	Description
540836	100	Ladder frame as attachment for high cabinets, including sliding rail for hook-in ladders, height 100 mm
540837	165	Ladder frame as attachment for high cabinets, including sliding rail for movable ladders, height 170 mm

CNS 18/10

Item No.	Height mm	Description
530836	100	Ladder frame as attachment for high cabinets, including sliding rail for hook-in ladders, height 100 mm
530837	165	Ladder frame as attachment for high cabinets, including sliding rail for movable ladders, height 170 mm

Ladders

Aluminium

Item No.	Description
145505	Hook-in ladder - ALUMINIUM - H - 2170 mm
145506	Movable ladder/Rolling ladder - ALUMINIUM - H - 2170
MC0037	Parking position for hook-in ladder

Screens as per DIN and ISO standard

Screens for cabinets as per DIN and ISO standard

Angled-roof screen

15 mm at front, 234 mm at rear,

up to a length of 1960 mm with powder-coated steel paint, up to a length of 750 mm with CNS
in the widths: 300 mm, 380 mm, 480 mm,
580 mm and 680 mm

Powder-coated

CNS 18/10

Item No.	Item No.
542391	542411

Cut-out in ceiling screens

Item No.	Description
602165	Length up to 800 mm

Cut-out in cabinet rear wall including screen

Item No.
602135

Wall shelf

Wall shelf





Model MWR

Surface sanded with 240 grain

Wall shelves, smooth. Turned down 30 mm on all sides

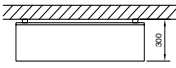
Load-bearing capacity with evenly distributed load 75 kg per running metre

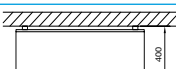
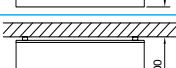
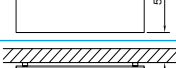
CNS 18/10

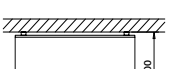
	Item No.	Depth mm	Description
	53699301	300	single-walled
	53699401	300	double-walled
	53699302	400	single-walled
	53699402	400	double-walled
	53699303	500	single-walled
	53699403	500	double-walled
	53699304	600	single-walled
	53699404	600	double-walled

VS wall-mount rails

Model VS

CNS 18/10

Item No.	Description
53699501	Model VS 0300
53699502	Model VS 0600
53699503	Model VS 0900
53699504	Model VS 1200
53699505	Model VS 1500
53699506	Model VS 1800
53699507	Model VS 2000

Wall shelf

Brackets

Model KO-V

for wall-mount rails, height-adjustable

CNS 18/10

Item No.	Depth mm	Description
53699601	300	Required number of brackets: Shelf length 1000 mm - 2 pieces Shelf length 1600 mm - 3 pieces Shelf length 2200 mm - 4 pieces Shelf length 2600 mm - 5 pieces Shelf length 3200 mm - 6 pieces Shelf length 3800 mm - 7 pieces
53699602	400	Required number of brackets: Shelf length 800 mm - 2 pieces Shelf length 1300 mm - 3 pieces Shelf length 1800 mm - 4 pieces Shelf length 2200 mm - 5 pieces Shelf length 2600 mm - 6 pieces Shelf length 3000 mm - 7 pieces Shelf length 3400 mm - 8 pieces Shelf length 3800 mm - 9 pieces
53699603	500	Required number of brackets: Shelf length 800 mm - 2 pieces Shelf length 1300 mm - 3 pieces Shelf length 1800 mm - 4 pieces Shelf length 2200 mm - 5 pieces Shelf length 2600 mm - 6 pieces Shelf length 3000 mm - 7 pieces Shelf length 3400 mm - 8 pieces Shelf length 3800 mm - 9 pieces
53699604	600	Required number of brackets: Shelf length 700 mm - 2 pieces Shelf length 1100 mm - 3 pieces Shelf length 1500 mm - 4 pieces Shelf length 1900 mm - 5 pieces Shelf length 2300 mm - 6 pieces Shelf length 2700 mm - 7 pieces Shelf length 3100 mm - 8 pieces Shelf length 3500 mm - 9 pieces Shelf length 3800 mm - 10 pieces